



8 a.m. - 5 p.m. Sales Available
International: 1-919-443-0207
Toll Free: 1-888-551-3082



Visit Our Website
www.wakeindustrial.com



Email Us
sales@wakeindustrial.com

All Products from Wake Industrial, LLC, come with:

Sales and Repairs

We specialize in providing immediate product delivery when your system goes down. We have thousands of In-Stock automation products and offer a full range of repair options.

Fast Shipping

We ship worldwide, offering any type of shipping method with all the major logistic companies such as FedEx, UPS, DHL, USPS, and a variety of freight carriers.

Quality Guarantee

With standards like our 1 year warranty on ALL products, we can guarantee a better customer service experience than any other company within our industry.

Damage Free Delivery



All of our products are cleaned, go through quality control and are shipped using a custom military grade foam to ensure your product arrives undamaged. We have the capability to ship both small 1lb products and large 200lb+ automation parts regardless of your location.

Stay In Touch

Wake Industrial, LLC
1620 Old Apex Road
Cary, NC 27513

Wake Industrial is not affiliated with nor an authorized distributor or representative of any manufacturers, brands or products listed.

Call: 1-888-551-3082
International: 1-919-443-0207
Fax: 1-919-267-1705

Email: sales@wakeindustrial.com
Website: www.wakeindustrial.com

Rexroth Servodyn-D Diagnostics, maintenance

1070 066 032
Ausgabe 03

Maintenance Guidelines



Title Rexroth Servodyn-D
Diagnostics, maintenance

Type of Documentation Maintenance Guidelines

Document Typecode DOK-SERV*D-DIAGNOSTICS-WA03-EN-P

Purpose of Documentation The present manual informs you about the diagnostics options of the Servodyn-D drive series.

Record of Revisions

Description	Release Date	Notes
DOK-SERV*D-DIAGNOSTICS-WA03-EN-P	07.2003	Software releases refer to page 1–10

Copyright © Bosch Rexroth AG, 1998 – 2003

Copying this document, giving it to others and the use or communication of the contents thereof without express authority, are forbidden. Offenders are liable for the payment of damages. All rights are reserved in the event of the grant of a patent or the registration of a utility model or design (DIN 34–1).

Validity The specified data is for product description purposes only and may not be deemed to be guaranteed unless expressly confirmed in the contract. All rights are reserved with respect to the content of this documentation and the availability of the product.

Published by Bosch Rexroth AG
Postfach 11 62
D-64701 Erbach
Berliner Straße 25
D-64711 Erbach
Tel.: +49 (0) 60 62/78-0
Fax: +49 (0) 60 62/78-4 28
Abt.: BRC/ESM11 (WE)

Contents

Contents

	Page
1	Safety Instructions 1–1
1.1	Intended use 1–1
1.2	Qualified personnel 1–3
1.3	Safety markings on products 1–4
1.4	Safety instructions in this manual 1–5
1.5	Safety instructions for the described product 1–6
1.6	Documentation, software release and trademarks 1–9
2	Mains connection at the place of installation 2–1
2.1	Earthing 2–1
2.2	Earth-leakage circuit-breaker 2–3
3	Marks, certifications 3–1
3.1	CE-marking 3–1
3.2	EU design type certification 3–2
3.3	UL/CSA certification 3–3
4	Diagnostics displays at the drive 4–1
4.1	VMA..KB, VMA..KE status, warning and error displays 4–1
4.2	VMA..KR, VMA..B,C,D,F status displays 4–2
4.3	VMA..KR, VMA..B,C,D,F warning displays 4–3
4.4	Status displays DM and DS (without frequency inverter) 4–4
4.5	VMA..KR, VMA..B,C,D,F and DM/DS error displays (without frequency inverter) 4–5
4.5.1	List of error number in parameter P-0-0095 4–14
4.6	PROFIBUS-DP errors 4–28
4.7	DMA computer errors (without SERCOS interface) 4–28
4.8	Servodyn-D frequency inverter displays 4–29
4.8.1	Status/warning displays 4–29
4.8.2	Error displays 4–31
5	Connection overview 5–1
5.1	VMA..KB, VMA..KE supply module (with ballast switch) 5–1
5.2	VMA..KR, VMA..B,C,D,F supply module (with current regeneration) 5–2
5.3	DMA module with analog interface or positioning function (MC) 5–3
5.4	DMA module with SERCOS interface 5–4
5.5	DMA module with CAN bus 5–5
5.6	DMA module with PROFIBUS-DP 5–6
5.7	DM..8001-D frequency inverter with analog interface 5–7
5.8	Stand-alone module DS, supply unit 5–8
5.8.1	Overview of DS..K xxx2-D (in set-up mode) 5–8

Contents

5.9	Overview of DS..K xxx1-D	5–9
6	Replacing components	6–1
6.1	Motors	6–1
6.2	Drive modules	6–3
6.2.1	VM...K and DM...K	6–3
6.2.2	DC link connection of VMA..B,C,D and DMA..A,B,D with backplane modules	6–4
6.2.3	DC link connection of VMW..F and DMW..F with water cooling	6–5
A	Annex	A–1
A.1	Index	A–1

1 Safety Instructions

Please read this manual before commissioning the Servodyn-D drives. Store this manual in a place to which all users have access at any time.

1.1 Intended use

This manual contains information required for the intended use of this product.

The described low-voltage motors are intended for use in **commercial or industrial systems**. They comply with the harmonized standards of the VDE 0530/EN 60034 series. Their use in potentially explosive atmospheres is not admissible unless expressly permitted by additional instructions.

Air-cooled designs are rated for ambient temperatures ranging between -20 to $+40$ °C, and an operating altitude of ≤ 1000 m above sea level. Rating plate specifications deviating from this standard must be strictly observed. Conditions at the operating site must correspond to all specifications stated on the rating plate.

Low-voltage motors comprise **components** intended for integration into machines as contemplated by the EU Declaration of Conformity, as defined by Machinery Directive (98/37/EC, 98/79/EC). Before putting the motors into operation, ensure that the machine the motors are to be installed in meets the stipulations of the Machinery Directive (note also EN 60204-1).

The drive inverters described

- have been developed, manufactured, tested and documented in compliance with the safety standards. These products normally pose no danger to persons or property if they are used in accordance with the handling stipulations and safety notes prescribed for their configuration, mounting, and proper operation.
- comply with the requirements of
 - the EMC Directives (89/336/EEC, 93/68/EEC and 93/44/EEC)
 - the EMC product standard EN 61800-3 + A11
 - the Low-Voltage Directive (73/23/EEC)
 - the harmonized standards EN 50178 (VDE 0160) and EN 60146-1-1 (VDE 0558-11)
- are designed for operation in industrial environments, i.e.
 - no direct connection to public low-voltage power supply,
 - connection to the medium- or high-voltage system via a transformer.

In residential environments, in trade and commerce as well as small enterprises class A equipment may only be used if the following warning is attached:

Safety Instructions

 **This is a Class A device. In a residential area, this device may cause radio interference. In such case, the user may be required to introduce suitable countermeasures, and to bear the cost of the same.**

Before putting the drive inverters into operation, ensure that the machine which the inverters are to be installed in meets the stipulations of the Machinery Directive (98/37/EC, 98/79/EC) and the EMC Directive (89/336/EEC).

The faultless, safe functioning of the product requires proper transport, storage, erection and installation as well as careful operation.

Safety Instructions

1.2 Qualified personnel

The requirements as to qualified personnel depend on the qualification profiles described by ZVEI (central association of the electrical industry) and VDMA (association of German machine and plant builders) in:

Weiterbildung in der Automatisierungstechnik
edited by: ZVEI and VDMA
MaschinenbauVerlag
Postfach 71 08 64
D-60498 Frankfurt.

The present manual is designed for drive specialists.

Programming, start and operation as well as the modification of program parameters is reserved to properly trained personnel! This personnel must be able to judge potential hazards arising from programming, program changes and in general from the mechanical, electrical, or electronic equipment.

Interventions in the hardware and software of our products, unless described otherwise in this manual, are reserved to specialized Rexroth personnel.

Tampering with the hardware or software, ignoring warning signs attached to the components, or non-compliance with the warning notes given in this manual may result in serious bodily injury or damage to property.

Only electrotechnicians as recognized under IEC 826-09-01 (modified) who are familiar with the contents of this manual may install and service the products described.

Such personnel are

- those who, being well trained and experienced in their field and familiar with the relevant norms, are able to analyze the jobs being carried out and recognize any hazards which may have arisen.
- those who have acquired the same amount of expert knowledge through years of experience that would normally be acquired through formal technical training.

With regard to the foregoing, please note our comprehensive range of training courses. Please visit our website at

<http://www.boschrexroth.com>

for the latest information concerning training courses, teachware and training systems. Personal information is available from our Didactic Center Erbach,

Telephone: (+49) (0) 60 62 78-600.

Safety Instructions

1.3 Safety markings on products



Warning of dangerous electrical voltage!



Warning of hot surface > 60 °C!



Electrostatically sensitive components!



Warning of hazardous light emissions (optical fiber cable emissions)!



Protect against shock and impact!



Lug for connecting PE conductor only!



Connection of shield conductor only



The hazard signs

- “Warning of dangerous electrical voltage”, and
- “Warning of hot surface”

supplied together with the motors must be attached to the motors after installation in a visible location in accordance with the Machinery Directive (98/37/EC, 98/79/EC) if motor surfaces are exposed.

Safety Instructions

1.4 Safety instructions in this manual

**DANGEROUS ELECTRICAL VOLTAGE**

This symbol is used to warn of a **dangerous electrical voltage**. The failure to observe the instructions in this manual in whole or in part may result in **personal injury**.

**DANGER**

This symbol is used wherever insufficient or lacking compliance with instructions may result in **personal injury**.

**CAUTION**

This symbol is used wherever insufficient or lacking compliance with instructions may result in **damage to equipment or data files**.

 This symbol is used to draw the user's attention to special circumstances.

★ This symbol is used if user activities are required.

Safety Instructions

1.5 Safety instructions for the described product



DANGER

Danger of life through inadequate EMERGENCY-STOP devices! EMERGENCY-STOP devices must be active and within reach in all system modes. Releasing an EMERGENCY-STOP device must not result in an uncontrolled restart of the system! First check the EMERGENCY-STOP circuit, then switch the system on!



DANGER

**Danger for persons and equipment!
Test every new program before starting up a system!**



DANGER

**Retrofits or modifications may adversely affect the safety of the products described!
The consequences may include severe injury, damage to equipment, or environmental hazards. Possible retrofits or modifications to the system using third-party equipment therefore have to be approved by Rexroth.**



DANGER

**Health hazards through destroyed electrical components!
Do not destroy any built-in components. Dispose of destroyed components in a proper manner.**



DANGER

Do not look directly into the LEDs in the optical fiber connection. Due to their high output, this may result in eye injuries. When the inverter is switched on, do not look into the LED or the open end of a short connected lead.



DANGER

Please note your local, system-specific regulations and requirements as well as the proper use of tools, hoisting and transport equipment as well as the applicable standards, regulations, and accident prevention regulations.

Safety Instructions

**DANGEROUS ELECTRICAL VOLTAGE**

Unless described otherwise, maintenance works must be performed on inactive systems! The system must be protected against unauthorized or accidental reclosing.

Measuring or test activities on the live system are reserved to qualified electrical personnel!

**DANGEROUS ELECTRICAL VOLTAGE**

Lethal voltages of up to 375 V DC against ground on all power connections and DC link connections!

The drives must not be switched on unless all covers have been fitted! When the drive has been disconnected from mains, wait for up to 5 minutes until the system is de-energized before removing any covers.

The drive must always be examined for safe isolation from supply!

**DANGER – WARNING OF HOT SURFACE!**

The surfaces of motors can reach temperatures of up to approx. 100 °C.

A touch guard is to be provided where necessary.

**CAUTION**

Impacts and shocks applied to the shaft end will damage the rotary encoder and ball bearings!

Drive elements such as pulleys, clutch disks, toothed wheels etc. may only be assembled or removed by continuously heating up the drive elements or with a suitable installation or removal tool. Use the thread in the shaft end.

**CAUTION**

use only spare parts approved by Rexroth!

**CAUTION**

Damages to the module or inverter by removing plug-in connections.

All plug-in connections to the encoder may only be inserted or removed while the drive is switched off.

Safety Instructions



CAUTION

Observe all precautions for ESD protection when handling modules and components! Avoid electrostatic discharge!

The following protective measures must be observed for modules and components sensitive to electrostatic discharge (ESD)!

- Personnel responsible for storage, transport, and handling must have training in ESD protection.
- ESD-sensitive components must be stored and transported in the prescribed protective packaging.
- ESD-sensitive components may only be handled at special ESD-workplaces.
- Personnel, working surfaces, as well as all equipment and tools which may come into contact with ESD-sensitive components must have the same potential (e.g. by grounding).
- Wear an approved grounding bracelet. The grounding bracelet must be connected with the working surface through a cable with an integrated 1 M Ω resistor.
- ESD-sensitive components may by no means come into contact with chargeable objects, including most plastic materials.
- When ESD-sensitive components are installed in or removed from equipment, the equipment must be de-energized.

Safety Instructions

1.6 Documentation, software release and trademarks

Documentation

The present manual informs you about the diagnostics options of the Servodyn-D drive series.

Overview of available documentation	Part no.			
	German	English	French	Italian
Servo motors SF, SR	1070 066 004	1070 066 024	1070 066 048	1070 066 046
Asynchronous motors DU	1070 066 007	1070 066 027	–	–
Servodyn-D, Configuration - Manual for overview and rating	1070 066 009	1070 066 029	1070 066 059	1070 066 049
Servodyn-D, Connectivity Manual	1070 066 010	1070 066 030	1070 066 060	1070 066 050
Servodyn-D, - Connectivity Manual - Stand alone version	1070 066 016	1070 066 036	1070 066 066	1070 066 056
Servodyn-D, Servodyn-M - Parameter manual (without CANopen)	1070 066 018	1070 066 038	1070 066 068	1070 066 058
Servodyn-D, Servodyn-M - Parameter manual CANopen	1070 066 094	1070 066 095	–	–
Servodyn-D with SERCOS interface - Parameter and commissioning manual	1070 066 011	1070 066 031	–	1070 066 051
Servodyn-D with analog interface - Commissioning manual	1070 066 014	1070 066 034	–	–
Servodyn-D with CANrho interface - Commissioning manual	1070 066 017	1070 066 037	–	–
Servodyn-D with motion control - Commissioning manual	1070 066 015	1070 066 035	–	–
Servodyn-D with PROFIBUS-DP - Commissioning manual	1070 066 090	1070 066 091	–	–
Servodyn-D DM/DS..8001 (ASM) Parameter and commissioning manual	1070 066 008	1070 066 028	–	1070 066 053
Diagnostics, maintenance	1070 066 012	1070 066 032	1070 066 062	1070 066 052
RSU, Redundant safety monitoring	1070 066 006	1070 066 026	1070 066 081	1070 066 082
EMC manual	1070 066 072	1070 066 074	1070 066 075	1070 066 076
External load switching module EBX	1070 066 077	1070 066 080	–	–

 **In this manual the floppy disk drive always uses drive letter A:, and the hard disk drive always uses drive letter C:.**

Special keys or key combinations are shown enclosed in pointed brackets:

- Named keys: e.g., <Enter>, <PgUp>,
- Key combinations (pressed simultaneously): e.g., <Ctrl> + <PgUp>

Safety Instructions

Release

 **The present manual applies to the following releases:**

DM/DS software:	SERCOS interface	V0.049 or higher
	CANopen/rho	V0.002 or higher
	Analog interface	V0.17 or higher
	PROFIBUS-DP	V0.004 or higher
	Motion Control	V0.010 or higher
VM software:	V0.045 or higher	

- The current software release number can be viewed by selecting parameter S-0-0030 with the DSS-D Commissioning and Service System, or in the "Software" field of the module configuration display (DIAGNOSTICS ► MODULE CONFIGURATION).
- For information concerning the current DSS software release, refer to HELP ► ABOUT...
- The current software release of VMA..KR and VMA..B,C,D,F can only be read from the 7-segment display during test operation. For this purpose, turn dip switch "T" on the VM's personality module "on":

The following appears in a running, flashing display:
"Cxx.ZZ.ddmmyyyy"

Where:

xx	= software release number
ZZ	= (internal)
dd	= software creation day
mm	= software creation month
yyyy	= software creation year

Trademarks

All trademarks of software installed on Rexroth products upon delivery are the property of the respective manufacturer.

Upon delivery, all installed software is copyright-protected. The software may only be reproduced with the approval of Rexroth or in accordance with the license agreement of the respective manufacturer.

MS-DOS® and Windows™ are registered trademarks of Microsoft Corporation.

PROFIBUS® is a registered trademark of the PROFIBUS Nutzerorganisation e.V. (user organization).

SERCOS interface™ is a registered trademark of Interessengemeinschaft SERCOS interface e.V. (Joint VDW/ZVEI Working Committee).

Mains connection at the place of installation

2 Mains connection at the place of installation



CAUTION

A reversed phase sequence or winding direction of a line reactor will destroy the mains connection module.
Please ensure proper wiring.

2.1 Earthing



CAUTION

Inverter modules may only be operated with an earthed neutral system.
Systems not directly earthed (IT protective system) must not be used for operation, as air clearances and leakage paths in the module may be overloaded.
Operation at asymmetrical mains systems (TT protective system, one mains phase is earthed) is not permissible!

DIN VDE 0100-300 defines mains systems subject to their type of earth connection.

Accordingly, in an IT protective system, all active parts are separated from earth, or one point is connected to earth via a resistor.

The exposed conductive parts of an electrical system are either

- earthed separately, or
- earthed jointly, or
- jointly connected to the system earth.

 Please note the information on earthing in the Servodyn-D EMC manual, for part no. refer to page 1–9.



DANGEROUS ELECTRICAL VOLTAGE

The only permissible protective measure in accordance with EN 50 178 is a protective earth connection.

The protective conductor must at least have the same area as the mains feeder.

Earthing only one end of the DC link when operating by means of an isolating transformer is prohibited!

Mains connection at the place of installation

Earth connections in the switch cabinet must be designed in the form of a grid mesh.

The module housing and mounting plate of the switch cabinet must be earthed. The connection between the line filter and the supply module should be as short as possible.

The protective earth cross-section must at least correspond to the cross-section of the line feeder of the supply module.



DANGER

Dangerous shock currents through inappropriate protective earth connections!

Do not impair protective earth connections by mechanical, chemical or electro-chemical influences. The connection must be firm and lasting.

Mains connection at the place of installation

2.2 Earth-leakage circuit-breaker

Inverters incorporate switched power units which are always associated with capacitive leakage currents against earth. The leakage currents may depend on the number of inverters, the earthing conditions as well as the design and length of motor power cables.

Mains filters and shielded cables used to improve the electromagnetic compatibility (EMC) increase the leakage currents further. For this reason, no earth-leakage circuit-breakers with nominal leakage currents of less than 300 mA may be used.



DANGEROUS ELECTRICAL VOLTAGE

Personnel protection is only guaranteed if earth-leakage circuit-breakers with nominal leakage currents of less than 30 mA are used.

 **Inductors and/or capacitors present in the electric circuit may lead to spurious trips. If radio interference suppression filters are used, spurious trips can only be avoided by installing an isolating transformer.**



DANGEROUS ELECTRICAL VOLTAGE

If a pulse power current sensitive e.l.c.b. type A in accordance with IEC-755 (VDE 0664) is used, its protective function is not guaranteed for inverters with a 3-phase mains connection (B6 circuit).

The protection of all electrical components connected together with inverters with a 3-phase mains connection to a pulse power current sensitive e.l.c.b. may be adversely affected.

Therefore, you should either install an isolating transformer with a protective device and earthing in the mains feeder, or use a universal current sensitive e.l.c.b. type B which also provides safety disconnection in the event of DC leakage currents.

Mains connection at the place of installation

Notes:

Marks, certifications

3 Marks, certifications

3.1 CE-marking

Low-Voltage Directive

The CE marking confirms compliance of drive modules of the Servodyn-D series with the Low-Voltage Directive. The rating and construction satisfy the requirements of EN 50178.

Machinery Directive

The CE marking confirms compliance of drive modules of the Servodyn-D series with the Machinery Directive. The rating and construction satisfy the requirements of EN 60204-1.

EMC Directive

Concerning the EMC Directive, the exception stipulated in the German EMC Act, EMVG Art. 6, Subs. (9), is applicable, cf. below. The following must be noted with respect to the operational system (cf. EMC manual):

- Requirements on EMC noise emission
 - Conducted noise
Depending on the application (industrial environment or domestic application), a suitable mains filter is to be provided in the power supply line.
The cubicle construction should be designed so as to ensure the efficiency of the mains filter to the greatest possible extent.
 - Radiated noise
Depending on the application (industrial environment or domestic application), a suitable switch cabinet with EMC shielding has to be provided.
For the motor leads, shielded cables should be preferably used which are grounded on both ends of the shield.
- Required interference immunity
The rating and construction satisfy the requirements of the EMC product standard EN 61800-3 for application in industrial environments.

EMVG 18.09.1998

Art. 6 Exceptions and special determinations

(9) Apparatuses, systems, and components covered by Subs. 3, which are exclusively manufactured and designed as accessories or spare parts for further processing by companies or persons with expert knowledge in the field of electromagnetic compatibility, are exempted from compliance with the protection requirements and the requirements of Art. 4 Subs. 1 Nos. 1 to 3 and 5. The operational unit which contains apparatuses, systems or components defined in the 1st sentence above, shall satisfy the provisions of this law.

Marks, certifications

3.2 EU design type certification

The certification covers Servodyn-D with redundant safety monitoring RSU. RSU complies with the requirements concerning:

- **Safety-relevant parts of controllers** in accordance with EN 954-1 Category 3, as required by
 - EN 12415 (safety of turning machines)
 - EN 12417 (safety of machining centres)
- **Control functions in the event of a fault** according to EN 60204-1

In the special mode, the integrated 2-channel safety structure monitors all axis and spindle movements. It is available for:

- Three-phase modules with SERCOS interface (firmware release as of V0.040)
- in connection with supply modules with energy recovery capability (firmware release as of V0.040) and
- mains connection module NAA

This concept has been certified, i.e. additional monitoring equipment is not necessary.

 **For more information, refer to Servodyn-D with Redundant Safety Monitoring manual, part no. in Section 1.6.**

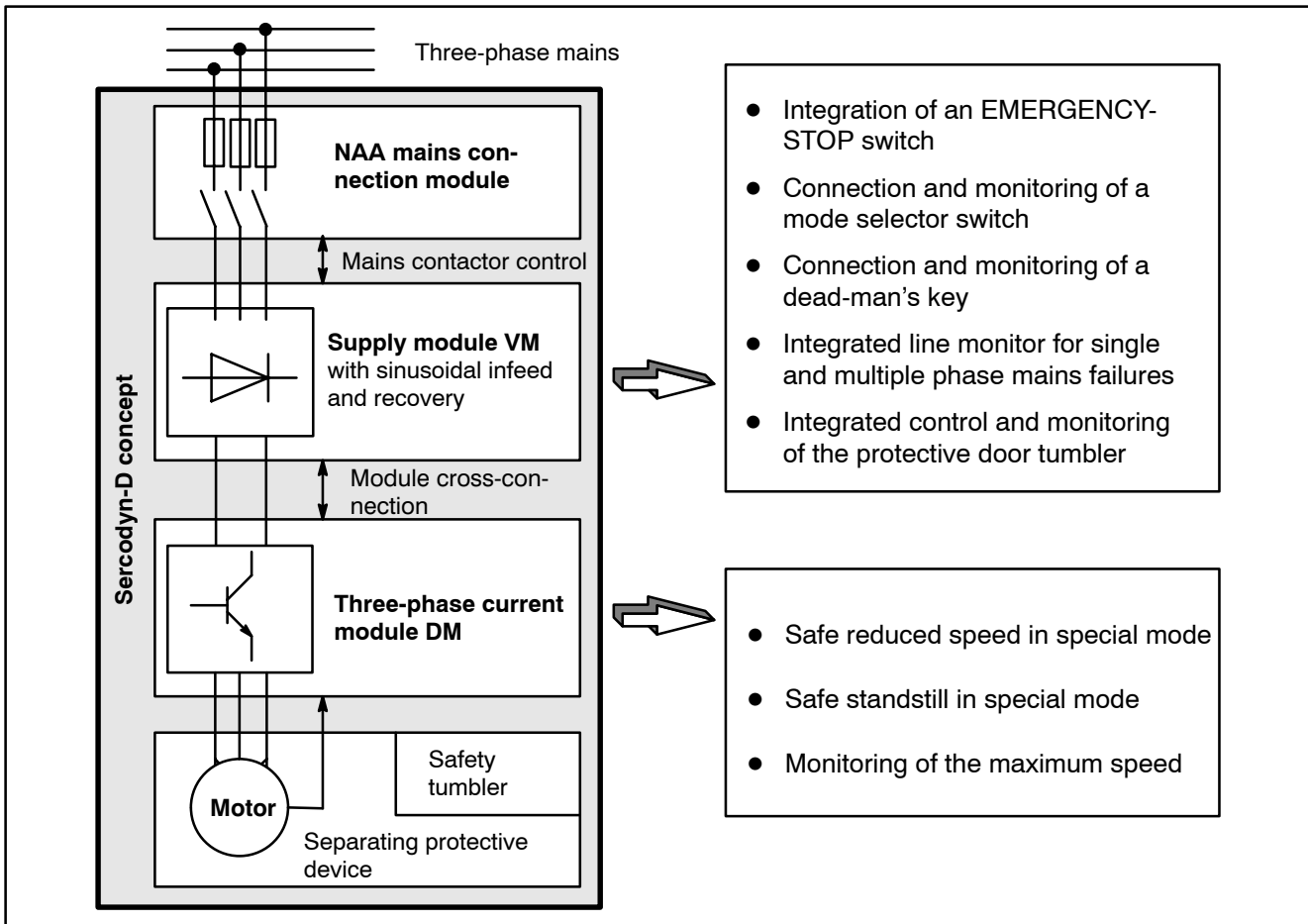

Marks, certifications

3.3 UL/CSA certification



For a number of Servodyn-D modules in compact mechanics, a UL/CSA certification is available for the U.S. and Canada. They are marked by adhesive labels. These modules are listed in the "Product Identity 23 MB", File No. E214694.

Installation in compliance with UL/CSA

In order to obtain a UL/CSA-compliant installation, the following must be noted in addition to the use of the certified components:

- Systems may only be used in environments with pollution severity 2.
- Note tightening torques of the connection terminals as specified in Interface Conditions manual, for part no. refer to page 1–9.
- The insulated wires must be specified for 60/75°C as a minimum.
- Only insulated Class 1 wires or equivalent may be used, e.g. to UL Style 1015 (on motor side, H07: U_0/U : 600/1000 V) and UL Style 1007 or 1569 (on supply side, H05: U_0/U : 300/500 V)
- Suitable for installation in symmetrical supply networks with a short-circuit current of ≤ 10 kA with max. 460 V +10 %.

Operation in compliance with UL/CSA

For UL/CSA-compliant operation, the bimetal function (I^2t monitoring) must be activated in the inverters using parameter P-0-0053 in order to provide motor protection.

- I_N of the motor is automatically retrieved from the electronic rating plate to the I^2t monitoring function.
- P-0-0053 is only used to set the desired time constant:

Factory setting:	0.0 (disabled)
Customary setting range:	100...150
	(corresponds to release characteristics of bimetal relay)









Marks, certifications

Notes:

VMA..KB, VMA..KE status, warning and error displays





4 Diagnostics displays at the drive

4.1 VMA..KB, VMA..KE status, warning and error displays

7-segment display	Status	Action
	Ready Standard ready display	—
	Warning: <ul style="list-style-type: none"> Excessive heat sink temperature Ballast switch may be overloaded VM power limit reached 	<ul style="list-style-type: none"> Increase air supply, reduce ambient temperature Reduce module load
	Undervoltage DC link voltage < 400 V	<ul style="list-style-type: none"> Switch module on Check system voltage
	Overvoltage DC link voltage > 800 V	<ul style="list-style-type: none"> Reduce braking current Check system voltage
	Ballast switch overload	<ul style="list-style-type: none"> Reduce braking current Set longer braking times
	Power supply fault Internal supply voltage outside permissible tolerance.	<ul style="list-style-type: none"> Check 24 V connection voltage Replace module
	Module overtemperature Heat sink temperature > 75°C	<ul style="list-style-type: none"> Increase air supply Reduce ambient temperature
	Ambient overtemperature Ambient temperature > 55°C	<ul style="list-style-type: none"> Check application conditions Observe derating

VMA..KR, VMA..B,C,D,F status displays

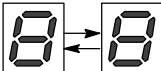
4.2 VMA..KR, VMA..B,C,D,F status displays

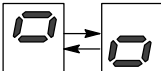
LED	Status	Action
 AE	Drive On LED lights up at 24 V at X06.7 (AE)	–
 FGI	Enable internal if <ul style="list-style-type: none"> • 24 V at X06.7 (AE) • no error 	–
	Multi-digit displays flash alternately.	
	Normal operation (NO) Standard ready display	–
	Special operating mode (SO) Operating mode for open safety door where standstill monitoring of the drives is still active at maximum energy supply.	–
	Intermediate circuit not yet discharged Alternate flashing while DC link voltage >50 V	Wait for a discharge time of 5 minutes and then check the DC link at the DC measuring sockets for zero voltage.



DANGEROUS ELECTRICAL VOLTAGE

Before dismantling the modules, wait for a discharge time of 5 minutes and check the DC link at the DC measuring sockets for zero voltage.





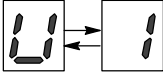
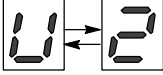
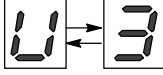
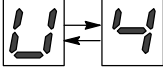
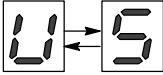



VMA..KR, VMA..B,C,D,F warning displays

4.3 VMA..KR, VMA..B,C,D,F warning displays

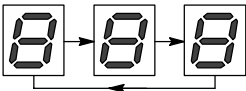
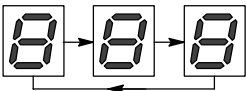
Displays flash alternately	Warning	Action
	The drive can switch off without delay.	
	Overload Output limit of the VM reached during supply or regeneration: <ul style="list-style-type: none"> • $P_{\max} > 140\%$, or • $P_N > 100\%$ 	In continuous operation: reduce load. When regenerating: select longer braking ramp by limiting braking current (P-0-0027)
	Overtemperature Heat sink temperature $> 75^\circ\text{C}$	<ul style="list-style-type: none"> • Check air supply • Check fan
	Overtemperature Ambient temperature $> 45^\circ\text{C}$	<ul style="list-style-type: none"> • Check application conditions • Observe derating
	Power failure, 1 phase The VM maintains axis supply, although the output is reduced to 66 %. Overload may result if failure of one phase is long-term.	<ul style="list-style-type: none"> • Check fuses and line system • Check wiring • Replace power supply module NA
	Power failure, 2 or 3 phase $U_{\text{system rms}} < 70\%$ for more than 3 ms. The DC link can be temporarily supported by the axes, which are informed of the power failure via the module cross connection.	<ul style="list-style-type: none"> • Check fuses and line system • Check wiring • Replace power supply module NA

Status displays DM and DS (without frequency inverter)

4.4 Status displays DM and DS (without frequency inverter)

LED	Status	Action
 FG	Axis enable external if <ul style="list-style-type: none"> • 24 V at X06.3 (FG) 	–
 FGI	Enable internal if <ul style="list-style-type: none"> • 24 V at X06.3 (FG) • Central enable by VM present • no error • Additionally with SERCOS interface: "Drive On" and "Drive Enable" output 	–
	Multi-digit displays flash alternately.	
	Open bus (only with SERCOS interface) The preset address value flashes : <ul style="list-style-type: none"> • before phase 0, if no signal has been received • in phase 2 and thereafter if the axis was not addressed in phase 1 	<ul style="list-style-type: none"> • in phase 0: check bus link • in phase 2 and later: check the setting of the axis address (DIP switch on personality module)
	Phase 0 Initialization phase. If system remains in phase 0: <ul style="list-style-type: none"> • Fault in phase run-up 	<ul style="list-style-type: none"> • Check initialization file (*.scs) • Contact controller's manufacturer
	Phase 1 (only with SERCOS interface) Initialization phase. If system remains in phase 1: <ul style="list-style-type: none"> • Fault in phase run-up 	<ul style="list-style-type: none"> • Check initialization file (*.scs) • Contact controller's manufacturer
	Phase 2 Initialization phase. If system remains in phase 2: <ul style="list-style-type: none"> • The parameters loaded into the drive during this phase are not all valid 	<ul style="list-style-type: none"> • Call up list of invalid operating data in phase 2 (S-0-0021) • Check input limits of parameters • Check parameters for completeness
	Phase 3 Initialization phase. If system remains in phase 3: <ul style="list-style-type: none"> • The parameters loaded into the drive during this phase are not all valid 	<ul style="list-style-type: none"> • Call up list of invalid operating data in phase 3 (S-0-0022) • Check input limits of parameters • Check parameters for completeness
	Phase 4 Operating phase. The drive has started up, communication has been established.	–

 **Phase run-up is performed so fast, especially if no bus interface is used, that the drive immediately displays phase 4 when it has been switched on.**

VMA..KR, VMA..B,C,D,F and DM/DS error displays

4.5 VMA..KR, VMA..B,C,D,F and DM/DS error displays (without frequency inverter)

☞ For a more detailed analysis, please refer to parameter S-0-0095, refer to page 4-14, where you will find a lot of specific information concerning the errors displayed at the drives.

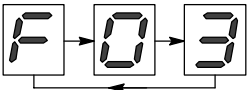
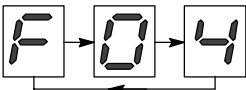
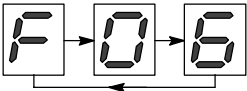
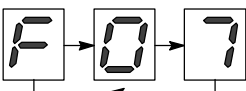
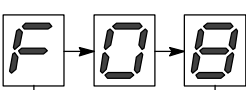
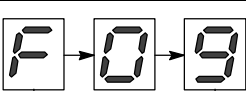
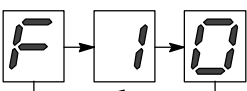
Displays flash alternately.	Error	Action
	Fault in option module Option module in drive slot is defective.	<ul style="list-style-type: none"> ● Check option module for firm seat ● Replace option module
	Overcurrent Admissible peak current exceeded.	<ul style="list-style-type: none"> ● Reduce load ● Select longer braking and acceleration ramps ● Check controller optimization ● Check motor ● Check application
	Real-time error Error in drive control during commissioning	<ul style="list-style-type: none"> ● Restart module ● Reduce computer load by DSS-D (e.g. turn oscilloscope off) ● Replace module
	Module overtemperature Excessive heat sink temperature	<ul style="list-style-type: none"> ● Check ambient temperature, increase air supply ● Check fan ● Reduce load
	Motor overtemperature Motor winding temperature > 145°C, temperature sensor or sensor cable defective.	<ul style="list-style-type: none"> ● Reduce motor load, use bigger motor ● Check cooling ● Check encoder cable ● Check application conditions
	Ambient overtemperature Ambient temperature > 55°C	<ul style="list-style-type: none"> ● Check application conditions ● Observe derating
	Communication error <ul style="list-style-type: none"> ● with SERCOS interface Communication lost, module jumps back to phase 0. ● with CAN bus No SYNC message 	<ul style="list-style-type: none"> ● SERCOS interface: After phase 2 start up, evaluate type of error and communication phase in which the error occurred (S-0-0014).

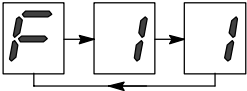
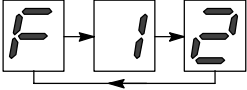
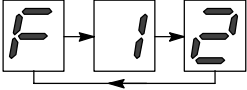
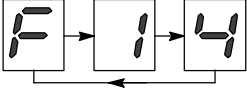
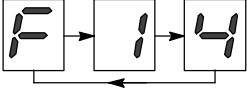

VMA..KR, VMA..B,C,D,F and DM/DS error displays

Displays flash alternately.	Error	Action
	<p>Normal operation: Encoder error Connection error, short circuit or interruption of encoder cable. Encoder, encoder evaluation or electronic rating plate defective.</p> <p>Special mode (RSU): Encoder slip Noise limiter overload (because of excessively long, shielded motor cables)</p>	<p>☞ For details of the fault, refer to S-0-0095, cf. page 4–14.</p> <p>For motor encoder and/or external encoder:</p> <ul style="list-style-type: none"> ● Check encoder connector ● Check encoder cable ● Replace motor ● Replace module <p>With RSU:</p> <ul style="list-style-type: none"> ● Check if max. 8 modules per VM ● Noise limiter overload if P-0-0047 ≈ 20 V
	<p>Trailing error, Standstill monitoring Axis moves without traversing command</p>	<ul style="list-style-type: none"> ● Check mechanical system
	<p>Excessive controller deviation Drive was not able to follow the setpoint inputs. DS modules: Undervoltage in DC link</p>	<ul style="list-style-type: none"> ● Compare max. setpoint input to speed limit (S-0-0091) ● Check lag ● DS: Check power supply ● SERCOS interface: Observe current limit for braking/acceleration (P-0-0061, P-0-0062); Increase acceleration limit S-0-0138; In mode “Special operation” adjust the setpoint input of the NC to the setup speed P-0-0012.
	<p>Position limit exceeded The setpoint input leads to an axis position outside the traversing range.</p>	<ul style="list-style-type: none"> ● Check position limit parameters S-0-0049 and S-0-0050 ● Check setting of software limit switches
	<p>Normal operation: Maximum speed exceeded (channel 1)</p> <ul style="list-style-type: none"> ● The speed limit value S-0-0091 was exceeded. <p>Special operating mode (RSU): Deviation from Safe Standstill (channel 1)</p> <ul style="list-style-type: none"> ● The angle of rotation limit value P-0-0022 was exceeded. <p>Special mode with acknowledgement (RSU): Deviation from Safe Speed (channel 1)</p> <ul style="list-style-type: none"> ● The speed limit value P-0-0012 was exceeded. 	<ul style="list-style-type: none"> ● Observe speed limit ● Observe sequence of operations ● Check enable signals ● Check control circuits ● Clear error by “Reset Diagnostics class 1 error” <p>☞ Check whether the fan on the bottom side of the module has failed.</p>

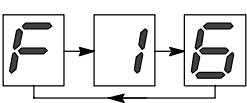
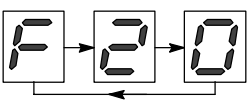
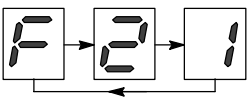
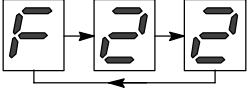
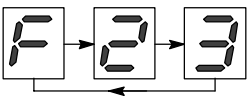
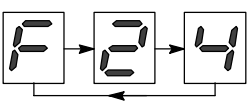
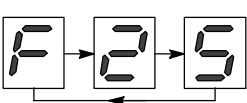
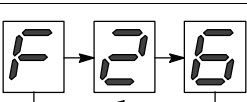

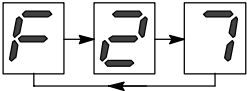
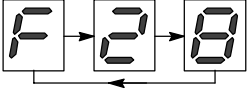
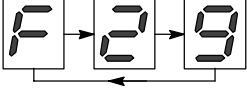
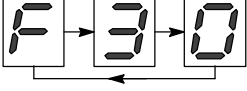
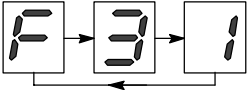

VMA..KR, VMA..B,C,D,F and DM/DS error displays

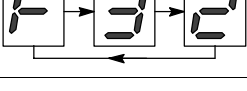
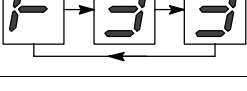
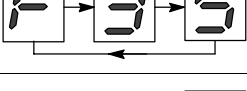
Displays flash alternately.	Error	Action
	<p>The drive has switched off.</p> <p>Normal operation: Maximum speed exceeded (channel 2)</p> <ul style="list-style-type: none"> The speed limit value S-0-0091 was exceeded. <p>Special operating mode (RSU): Deviation from Safe Standstill (channel 2)</p> <ul style="list-style-type: none"> The angle of rotation limit value P-0-0022 was exceeded. <p>Special mode with acknowledgement (RSU): Deviation from Safe Speed (channel 2)</p> <ul style="list-style-type: none"> The speed limit value P-0-0012 was exceeded. 	<ul style="list-style-type: none"> Observe speed limit Observe sequence of operations Check enable signals Check control circuits Clear error by a RESET on the DM, re-initialize SERCOS ring. Activate mains contactor with "Drive On". Replace VM if DMs and VM display the error simultaneously <p>☞ Check whether the fan on the bottom side of the module has failed.</p>
	<p>Charging circuit overloaded Energy loss in the charging resistors too high. Short circuit in DC link.</p>	<ul style="list-style-type: none"> Check wiring with "DC link connection terminal" in place Switch back on after approx. 5 min. Replace mains connection module Replace EBX module
	<p>Line reactor connection</p> <ul style="list-style-type: none"> The line reactor is incorrectly connected. Possible interaction with F22: Switch back on after 16 seconds 	<ul style="list-style-type: none"> Check line reactor connection Observe waiting time for reconnection (> 16 sec)
	<p>Charging circuit defective Line contactor K1 in the mains connection module is not energized. The display may change to F21 if switched back on within 16 sec.</p>	<ul style="list-style-type: none"> Set rotary switch S1 on VM to values > 0. Observe waiting time for reconnection (> 16 sec) Replace mains connection module
	<p>No DC link controller DC link cannot be adjusted according to setpoint.</p>	<ul style="list-style-type: none"> Replace supply module
	<p>Main contactor is not energized</p>	<ul style="list-style-type: none"> Replace mains connection module
	<p>Main contactor released The main contactor was released during operation.</p>	<ul style="list-style-type: none"> Replace mains connection module
	<p>Main contactor is not released</p>	<ul style="list-style-type: none"> Replace mains connection module

VMA..KR, VMA..B,C,D,F and DM/DS error displays

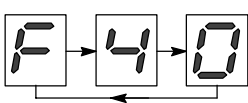
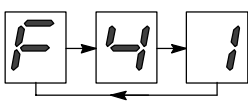
Displays flash alternately.	Error	Action
	<p>Load contactor is not released</p>	<ul style="list-style-type: none"> ● Replace mains connection module
	<p>Synchronization error in VM..B,C,D</p>	<ul style="list-style-type: none"> ● Check system voltage ● Replace supply module
	<p>Mains frequency Mains frequency < 48 Hz or > 62 Hz</p>	<ul style="list-style-type: none"> ● Check mains frequency
	<p>Overvoltage in DC link DC link voltage > 800 V (before: U1 warning display)</p> <p>Has several meanings on the VMW 180:</p> <ul style="list-style-type: none"> ● DC link overvoltage <p>Display may also appear if another error has been cleared with "Drive On".</p> <ul style="list-style-type: none"> ● Overcurrent in output stage ● Driver switched off because of overcurrent in output stage ● Driver circuit of the output stage defective 	<ul style="list-style-type: none"> ● Reduce feedback power (select longer delay time, reduce braking current) ● Note error message on VM ● Error can be cleared with "Drive On" ● After "Drive On" error can be cleared by module RESET ● After "Drive On" and module RESET error can be cleared by toggling 24-V off/on ● Error cannot be cleared. Replace module.
	<p>Undervoltage in DC link DC link voltage <400 V</p>	<ul style="list-style-type: none"> ● Reduce acceleration power of the axes (warning display U1 shown before on VM) ● A 2- or 3-phase mains failure may have been present (previously warning display U5 on the VM)
	<p>Overvoltage in system System voltage is too high</p>	<ul style="list-style-type: none"> ● Check system voltage
	<p>Undervoltage in system System voltage is too low</p>	<ul style="list-style-type: none"> ● Check system voltage
	<p>Power supply fault Internal logic supply voltages not in admissible range</p>	<ul style="list-style-type: none"> ● Replace module
	<p>Fault in external 24 V DC 24 V module supply not within permitted range</p>	<ul style="list-style-type: none"> ● Check 24 V supply at X30 of the supply module ● Check F1 miniature fuse in VM

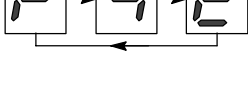
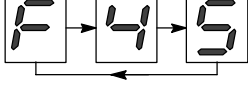

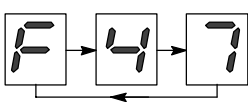
VMA..KR, VMA..B,C,D,F and DM/DS error displays

Displays flash alternately.	Error	Action
	<p>The drive has switched off.</p>	
	<p>Drives do not stand still Drives shutdown not completed when time limit has expired</p>	<ul style="list-style-type: none"> ● Check time limit setting in VM ● Check enable signals ● Clear error with "Drive On"
	<p>Channel error Emergency-Stop None of the channels was not switched within 0.5 sec</p>	<ul style="list-style-type: none"> ● Check Emergency-Stop wiring (X312.2, X06.3/4) ● Clear error by activating the Emergency Stop channel again, then unlocking Emergency Stop channel, then outputting "Drive On".
	<p>Channel error operating mode (RSU) Operating mode switchover via channels NO and SO does not take place within 2 sec.</p>	<ul style="list-style-type: none"> ● Check control of the VM inputs NO and SO (X312.3/4, X06.6) ● Check safety door tumbler control ● Clear error with "Drive On"
	<p>Channel error safety door tumbler (RSU) The check-back signal "safety door released" was not given within approx. 2 sec. in special mode</p>	<ul style="list-style-type: none"> ● Check safety door tumbler ● Check PLC check-back signal (X312.6) ● The VM should be replaced if there is a short-circuit in the driver of the safety door release (X312.5) ● Clear error with "Drive On"
	<p>Normal operating mode: Output stage cannot be switched off</p> <p>Special mode (RSU): Channel error Acknowledgement</p> <ul style="list-style-type: none"> ● The two acknowledgement channels have not been activated simultaneously (P-0-0024) ● Time limit P-0-0023 for acknowledgement exceeded <p>Channel error "Safe signal transmission" Defective signal transmission in X810 starting with module with this error message</p> <p>Channel error "Safety-oriented data" The cyclic safety-oriented data on the PM module and in the EEPROM are not identical</p>	<p>☞ For details of the fault, refer to S-0-0095, cf. page 4–14.</p> <ul style="list-style-type: none"> ● Clear error on the DMs by "Reset Diagnostics class 1 error", on the VM with "RESET" ● Replace module ● Check wiring (X312.1, X06.5) ● Check key for mechanical or electrical bridge ● Observe sequence of operations ● Check X810 signal cross-connection ● Replace module ● Check safety-oriented data ● Clear error by "Reset Diagnostics class 1 error"
	<p>Channel error FGZ (RSU) Defective transmission of the central enable signal from VM</p>	<ul style="list-style-type: none"> ● Check X810 signal cross-connection ● Replace module

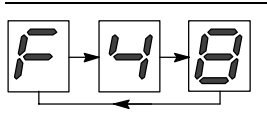
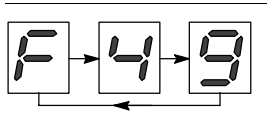
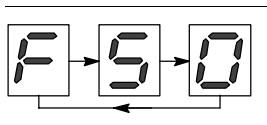
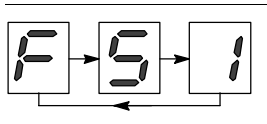
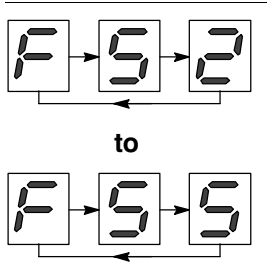
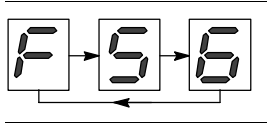
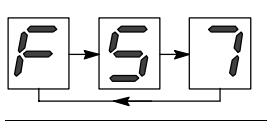
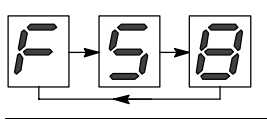
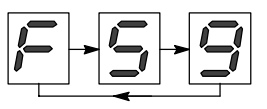
VMA..KR, VMA..B,C,D,F and DM/DS error displays

Displays flash alternately.	Error	Action
	<p>The drive has switched off.</p> <p>Normal operating mode: ASTS signal in module cross-connection not cleared properly</p> <p>Special mode (RSU): Channel error Drive shutdown The VM initiates "Drive shutdown", however, it cannot transmit this status through the module cross-connection.</p> <p>No 24 V supply The VM has detected that the 24 V supply is missing in the axis modules.</p>	<ul style="list-style-type: none"> ● Check X810 signal cross-connection ● Check X810 signal cross-connection ● Replace module ● 24 V connection, check 24 V connection
	<p>Time delay > (16 sec – S1) between the shutdown request for an axis and an additional Emergency Stop command of the NC/PLC (S1 = rotary switch on VM, front panel)</p> <p>Emergency Stop timer on VM defective</p>	<ul style="list-style-type: none"> ● Eliminate time overlap between "Drive shutdown" and "Emergency Stop" ● Toggle 24 V off / on or press RESET ● Replace supply module
	<p>CPU Test Microprocessor fault</p>	<ul style="list-style-type: none"> ● Replace module
	<p>RAM Test Fault in RAM memory</p>	<ul style="list-style-type: none"> ● Replace module
	<p>Checksum error</p>	<ul style="list-style-type: none"> ● Replace personality module or memory card
	<p>Update Memory Card Update of memory card was incorrect.</p>	<ul style="list-style-type: none"> ● Replace memory card
	<p>Watchdog error</p>	<ul style="list-style-type: none"> ● Replace module
	<p>Error in security test</p>	<ul style="list-style-type: none"> ● Replace module
	<p>Memory overflow</p>	<ul style="list-style-type: none"> ● Replace module

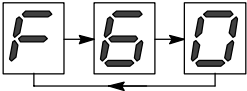
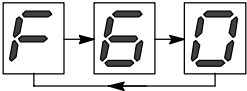
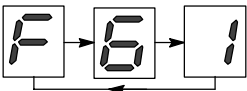
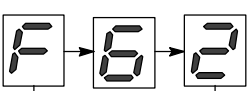
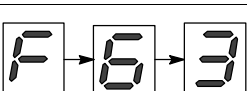
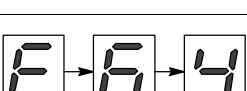
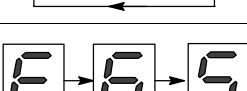
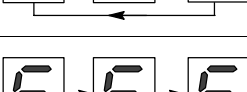
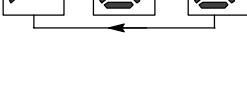
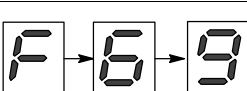
VMA..KR, VMA..B,C,D,F and DM/DS error displays

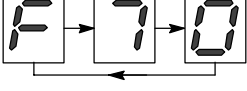
Displays flash alternately.	Error	Action
	The drive has switched off.	
	Initialization error I²C-Bus	<ul style="list-style-type: none"> ● Replace module
	Initialization error AD converter	<ul style="list-style-type: none"> ● Check motor cable ● Replace module
	Initialization error PWM3	<ul style="list-style-type: none"> ● Replace module
	Initialization error SERCOS tables	<ul style="list-style-type: none"> ● Replace module
	Initialization error overcurrent threshold	<ul style="list-style-type: none"> ● Replace module
	Initialization error Security (RSU)	<ul style="list-style-type: none"> ● Check signal cross-connection between modules ● Replace module
	Error in special mode (RSU): Channel error "Safety-oriented data" During initialization, the safety-oriented data on the PM module and in the EEPROM are not identical	<ul style="list-style-type: none"> ● Check safety-oriented data ● Clear error by "Reset Diagnostics class 1 error"
	Temperature measurement Timeout or wrong temperature sensor fitted to motor	<ul style="list-style-type: none"> ● Restart module ● Reduce computer load by DSS-D (e.g. turn oscilloscope or ADC output channels off) ● Replace motor
	Encoder fault Incorrect encoder initialization	<p>☞ For details of the fault, refer to S-0-0095, cf. page 4-14.</p> <ul style="list-style-type: none"> ● Connect permitted encoder ● Check encoder connection ● Replace motor/encoder
	Invalid driver ID	<ul style="list-style-type: none"> ● Replace module
	Assignment between module and software The software does not match the hardware.	<ul style="list-style-type: none"> ● Use suitable software

VMA..KR, VMA..B,C,D,F and DM/DS error displays

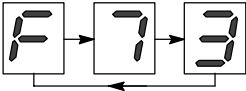
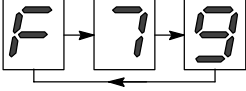
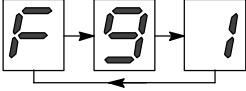
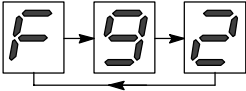
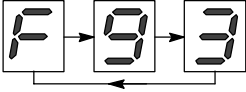
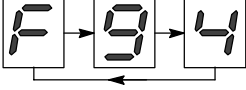
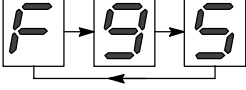
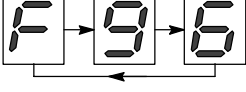
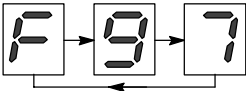
Displays flash alternately.	Error	Action
	<p>Assignment mains connection module – VM Mains connection module and supply module do not have the same power output stage.</p>	<ul style="list-style-type: none"> ● Combine compatible modules
	<p>CAN bus only: Internal command active The controller must not enable the drive at this time.</p>	
	<p>Runtime Personality Module</p>	<ul style="list-style-type: none"> ● Check stable position of personality module ● Replace personality module
	<p>Runtime I²C-Bus</p>	<ul style="list-style-type: none"> ● Replace module
	<p>Stacking error</p>	<ul style="list-style-type: none"> ● Replace module
	<p>Inadmissible memory access</p>	<ul style="list-style-type: none"> ● Replace module
	<p>Synchronization error I controller Internal synchronization of the VM firmware disturbed</p>	<ul style="list-style-type: none"> ● Replace module
	<p>Speed controller plausibility error</p>	<p>☞ For details of the fault, refer to S-0-0095, cf. page 4-14.</p> <ul style="list-style-type: none"> ● Check motor cable ● Switch modules off because of dangerous electrical voltage! Check DC link connection, check DC link voltage ● Motor stalled ● Turn off torque reduction ● For more details, refer to P-0-0010
	<p>VM error Torque is immediately turned off because of an operating fault (e.g. under-/overvoltage)</p>	<ul style="list-style-type: none"> ● Check error message on VM ● Clear error by “Reset Diagnostics class 1 error” <p>☞ Check whether the fan on the bottom side of the module has failed.</p>

VMA..KR, VMA..B,C,D,F and DM/DS error displays

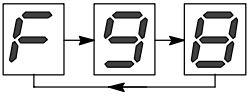
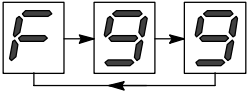
Displays flash alternately.	Error	Action
	<p>VM off with active control Motors are shut down because of a shut-down command</p> <p>Status message for DM with analog interface, MC, CAN bus and PROFIBUS-DP if the VM is switched off while the FG enable signal is high.</p>	<ul style="list-style-type: none"> ● Switch VM on ● Check EMERGENCY-STOP ● Clear error by “Reset Diagnostics class 1 error”
	<p>Other runtime errors</p>	<ul style="list-style-type: none"> ● Replace module

VMA..KR, VMA..B,C,D,F and DM/DS error displays

4.5.1 List of error number in parameter P-0-0095

Parameter P-0-0095 contains additional error numbers which provide for a more detailed analysis of various error displays of the modules. The following table is based on the F code display and lists the meaning of the error numbers:

F code display	Error number	Meaning
F03	0	Faulty option module in drive slot
F04	0	Overcurrent; Permitted peak current exceeded
F06	0	Realtime error; Excessive computer load; Defective module (watchdog)
	1	Realtime error; Watchdog I-controller has responded
	2	Realtime error; Watchdog N-controller has responded
	4	Realtime error; Watchdog X-controller has responded
F07	0	Heat sink overtemperature; Heat sink temperature > 80 °C
F08	0	Motor overtemperature; Motor winding > 145 °C; Defective temperature probe
F10	0	SERCOS interface communication error; Detailed diagnostics at S-0-0014
F11	0	Encoder fault; Detailed fault documentation unavailable at this time
	1	Motor encoder: Encoder signal voltage amplitude too low
	2	Motor encoder: Error in captured analog value
	4	Motor encoder: Two active counting slopes
	8	Motor encoder: Excessive RPM upon absolute-value capture
	16	Motor encoder: Short-circuit between encoder signals and GND, or power supply
	96	Motor encoder: Loose encoder (only in conjunction with RSU software)
	160	Motor encoder: Loose encoder (only in conjunction with RSU software)
	289	Motor encoder: Broken encoder coupling; Wrong encoder connected
	16384	Motor encoder: Wrong marker distance
	32768	Processing error in RSU software; Function: Redundant encoder monitoring
	50001	OM3 encoder: Encoder signal voltage amplitude too low
	50004	OM3 encoder: Two active counting slopes
	50016	OM3 encoder: Short-circuit between encoder signals and GND, or power supply
	50256	OM1/2 encoder: Two active counting slopes
	50512	OM1/2 encoder: Too many pulses per RPM
	51024	OM1/2 encoder: Too few pulses per RPM
	52048	OM1/2 encoder: Encoder signals A and AN not inverted
	54096	OM1/2 encoder: Encoder signals B and BN not inverted
	58192	OM1/2 encoder: Encoder signals R and RN not inverted
66384	External encoder: Wrong marker distance	
F12	0	Tracking error (zero-speed monitoring); Axis moves without traversing command

VMA..KR, VMA..B,C,D,F and DM/DS error displays

F code display	Error number	Meaning
F13	0	Excessive system deviation; Drive is unable to follow defined nominal value
	1	Monitoring error dual encoder
	2	Excessive system deviation spindle
F14	0	Positioning threshold exceeded;
F15	0	Software speed monitoring: Overspeed in Standard mode
	3	Software speed monitoring: Overspeed in Setup mode
	5	Software speed monitoring: Overspeed in zero-speed monitoring
F16	0	Hardware speed monitoring: Overspeed in Standard mode
	3	Hardware speed monitoring: Overspeed in Setup mode
	5	Hardware speed monitoring: Overspeed in zero-speed monitoring
F30	0	Overvoltage in DC link; DC link voltage > 670 V
F35	0	Power supply fault
F36	0	Faulty external 24 VDC power; 24 V module power outside of permissible range
F46	0	RSU channel error – detailed fault documentation unavailable at this time
	16	RSU: Hardware speed monitoring in Standard mode
	17	RSU: Hardware speed monitoring in non-standard operation
	32	RSU: Software speed monitoring in Standard mode
	33	RSU: Software speed monitoring in non-standard operation
	64	RSU: Channel error timeout expired in Standard mode
	65	RSU: Channel error timeout expired in non-standard mode
	128	RSU: Maximum dead-man interval expired in Standard mode
	129	RSU: Maximum dead-man interval expired in non-standard mode
	2048	RSU: Data comparison error in Standard mode
	2049	RSU: Data comparison error in non-standard mode
	4096	RSU: Data error, sensor calibration in Standard mode
	4097	RSU: Error: Data & sensor calibration in non-standard mode
	6144	RSU: Error: Data & sensor calibration in Standard mode
	6145	RSU: Data error, sensor calibration in non-standard mode
	8192	RSU: Error, high-level lockout in Standard mode
8193	RSU: Error, high-level lockout in non-standard mode	
8432	RSU: Error, Program process monitoring in Standard mode	
8433	RSU: Error, high-level lockout in non-standard mode	
F60	0	I2C-Initialization error – Detailed fault documentation unavailable at this time
F61	0	ADC-Initialization error – Detailed fault documentation unavailable at this time
F62	0	PWM – Initialization error; Defective module
F63	0	Initialization error – SERCOS tables
F64	0	Overcurrent – Initialization error; Defective module

VMA..KR, VMA..B,C,D,F and DM/DS error displays

F code display	Error number	Meaning	
F65	0	RSU: Security, Initialization error – Without detailed documentation	
	6	RSU: Security counter CNT0 does not count up	
	7	RSU: Security counter CNT0 does not count down	
	8	RSU: One security bit set prematurely	
	9	RSU: Clockwise max. monitoring does not respond	
	10	RSU: Clockwise setup monitoring does not respond	
	11	RSU: Clockwise zero-speed monitoring does not respond	
	12	RSU: Clockwise setup monitoring does not respond	
	13	RSU: Clockwise zero-speed monitoring does not respond	
	14	RSU: A security bit has responded upon counterclockwise rotation	
	15	RSU: Clockwise max. monitoring does not respond	
	16	RSU: Clockwise setup monitoring does not respond	
	17	RSU: Clockwise zero-speed monitoring does not respond	
	18	RSU: Clockwise setup monitoring does not respond	
	19	RSU: Clockwise zero-speed monitoring does not respond	
	20	RSU: Wrong SECSR error bits and/or info bits	
	21	RSU: CNT1 SECURITY counter not zero	
	22	RSU: Wrong SECSR error bits and/or info bits	
	23	RSU: CNT1 SECURITY counter not zero	
	24	RSU: Wrong SECSR error bits and/or info bits	
	25	RSU: CNT0 SECURITY counter not zero	
	26	RSU: CNT1 SECURITY counter not zero	
	27	RSU: Wrong SECSR error bits and/or info bits	
	28	RSU: Wrong SECSR error bits and/or info bits	
	38	RSU: Incorrect decoding of PSVM non-standard status	
	39	RSU: Error in LSR bits 11–15 (PSVM decoding)	
	40	RSU: PSVM error bit in LSR register not HIGH	
	47	RSU: PSVM test error: Faulty LPMR CTR count	
	F66	0	RSU-Initialization error – detailed fault documentation unavailable at this time
		1	RSU – Memory read error
2		RSU – Memory write error	
4		RSU – Memory, Error in data record	

VMA..KR, VMA..B,C,D,F and DM/DS error displays

F code display	Error number	Meaning
F70	0	Measuring system initialization error – Without detailed fault documentation
	1	Defective motor rating plate; faulty data transfer
	2	Missing interface → Defective cable, loose connection, defective rating plate
	3	Defective motor rating plate
	4	Motor rating plate without parameters
	5	Faulty data transfer; Defective memory location in motor rating plate
	6	Defective encoder; Faults upon absolute-value data transfer
	7	Defective encoder; Faulty data transfer (absolute-value parity check)
	8	Missing hardware trigger on pin NP_2 (zero-marker-storage-error)
	9	Missing interface; Defective cable; Loose connection; Defective rating plate
	11	Missing interface; Defective cable; Loose connection; Defective rating plate
	12	Missing interface; Defective cable; Loose connection; Defective rating plate
	13	Missing interface; Defective cable; Loose connection; Defective rating plate
	14	Missing interface; Defective cable; Loose connection; Defective rating plate
	15	Missing interface; Defective cable; Loose connection; Defective rating plate
	16	Missing interface → Software error
	84	Defective motor rating plate
	85	Defective motor rating plate
	86	Faulty data transfer; Defective motor rating plate
	87	Faulty data transfer; Defective motor rating plate
	88	Faulty data transfer; Defective motor rating plate
	89	Faulty data transfer; Defective motor rating plate
	90	Faulty data transfer; Defective motor rating plate
	91	Faulty data transfer; Defective motor rating plate
	92	Faulty data transfer; Defective motor rating plate
	93	Faulty data transfer; Defective motor rating plate
	94	Faulty data transfer; Defective memory location in motor rating plate
	95	Motor rating plate without parameters
	96	Missing interface; Defective cable; Loose connection; Defective motor rating plate
	97	Missing interface; Defective cable; Loose connection; Defective motor rating plate
	98	Faulty data transfer; Defective motor rating plate
	99	Faulty data transfer (CRC check, motor rating plate)
	100	Faulty data transfer; Defective motor rating plate
101	Faulty data transfer (CRC check, motor rating plate)	
102	Motor rating plate without parameters	
103	Faulty data transfer; Defective memory location in motor rating plate	
104	Faulty data transfer; Defective memory location in motor rating plate	
105	Faulty data transfer (CRC check, motor rating plate)	
106	Defective encoder → Signal amplitude too low; Missing illumination	

VMA..KR, VMA..B,C,D,F and DM/DS error displays

F code display	Error number	Meaning
F70	107	Defective encoder; Faults upon absolute-value data transfer
	108	Missing hardware trigger on pin NP_2 (zero-marker-storage-error)
	109	Internal rating plate without parameters
	110	Defective memory location in internal rating plate
	111	Defective memory location in internal rating plate
	113	Software error (flash memory not addressable/responding)
	114	Software error (flash memory not addressable/responding)
	115	Defective SDCL-ASIC on option module 3
	117	Error incremental-encoder →Two active counting slopes;Amplitude too low
	118	Module with resolver interface ↔ Motor without resolver
	119	Motor with resolver ↔ Module without resolver interface
	120	Reading absolute value not possible with internal rating plate
	121	Software error → Reading absolute value without valid interface
	122	Encoder cable break at EnDat or SSI interface
	123	Defective encoder;Excessive speed upon initialization (error quadra. correction)
	124	Defective encoder; Excessive RPM upon initialization (error quadran. correction)
	125	Defective ext. encoder; Excessive speed upon initializ. (err quadr. correction)
	126	Defective ext. encoder; Excessive RPM upon initializ. (error quadra. correction)
	127	Missing interface; Defective cable; Loose fasteners; Defective rating plate
	128	No binary interrelation between encoder pulses and absolute singleturn value
	129	Motor rating plate: Parameter set 1 without parameters
	130	Motor rating plate: Parameter set 1 without parameters
	131	Flash rating plate: Parameter set 1 without parameters
	132	Motor rating plate: Parameter set 1 without parameters
	133	Motor rating plate: Defective memory location, parameter set 1 (checksum error)
	134	Motor rating plate: Defective memory location, parameter set 1 (checksum error)
	135	Flash rating plate: Defective memory location, parameter set 1 (checksum error)
	136	Motor rating plate: Defective memory location, parameter set 1 (checksum error)
	137	Motor rating plate: Parameter set 2 without parameters
	138	Motor rating plate: Parameter set 2 without parameters
	139	Flash rating plate: Parameter set 2 without parameters
	140	There is no 2nd parameter set for SSI interface
	141	Motor rating plate: Defective memory location, parameter set 2 (checksum error)
	142	Motor rating plate: Defective memory location, parameter set 2 (checksum error)
	143	Flash rating plate: Defective memory location, parameter set 2 (checksum error)
	144	There is no 2nd parameter set for SSI interface
300	Faulty parameter transfer from DSS to drive (checksum error)	
301	Faulty parameter transfer from DSS to drive (checksum error)	
302	SSI interface not addressable (defective cable; loose connection ...)	

VMA..KR, VMA..B,C,D,F and DM/DS error displays

F code display	Error number	Meaning
F70	303	Faulty data transfer; Defective motor rating plate
	304	Faulty data transfer; Defective motor rating plate
	305	I2C bus not addressable (defective cable; loose connection, misc. faults ...)
	306	Faulty data transfer; Defective motor rating plate
	307	Faulty data transfer; Defective motor rating plate
	308	Faulty data transfer; Defective motor rating plate
	309	Faulty data transfer; Defective motor rating plate
	310	Faulty data transfer; Defective motor rating plate
	311	Faulty data transfer; Defective motor rating plate
	312	Faulty data transfer; Defective motor rating plate
	313	Faulty data transfer (CRC check, motor rating plate)
	314	Faulty data transfer; Defective motor rating plate (checksum test)
	315	Faulty data transfer; Defective motor rating plate (checksum test)
	316	Faulty data transfer; Defective motor rating plate (checksum test)
	317	Faulty data transfer; Defective motor rating plate (checksum test)
	318	Missing motor interface; Defective cable; Loose connection; Defective rating plate
	319	There is no 2nd parameter set for SSI interface
	320	Faulty data transfer; Defective motor rating plate
	321	Faulty data transfer (CRC check, motor rating plate)
	322	Unable to clear internal flash memory → Defective memory location
	323	Unable to write to internal flash memory → Defective memory location
	324	Unable to write to internal flash memory → Defective memory location
	325	Defective memory location in internal flash module (checksum test)
	326	Defective memory location in internal flash module (checksum test)
	329	I2C bus not addressable (defective cable; loose connection, misc. faults ...)
	331	I2C bus not addressable (defective cable; loose connection, misc. faults ...)
	332	I2C bus not addressable (defective cable; loose connection, misc. faults ...)
	333	I2C bus not addressable (defective cable; loose connection, misc. faults ...)
	334	I2C bus not addressable (defective cable; loose connection, misc. faults ...)
	335	I2C bus not addressable (defective cable; loose connection, misc. faults ...)
	1201	Motor rating plate: Parameter set 1: Motor type = 0
	1202	Motor rating plate: Parameter set 1: Version number = 0
	1203	Motor rating plate: Parameter set 1: Encoder pulses = 0
	1204	Motor rating plate: Parameter set 1: Nominal velocity = 0
	1205	Motor rating plate: Parameter set 1: Max. velocity = 0
1206	Motor rating plate: Parameter set 1: Nominal current = 0	
1207	Motor rating plate: Parameter set 1: Standstill current = 0	
1208	Motor rating plate: Parameter set 1: Maximum current = 0	
1209	Motor rating plate: Parameter set 1: Rated torque = 0	

VMA..KR, VMA..B,C,D,F and DM/DS error displays

F code display	Error number	Meaning
F70	1210	Motor rating plate: Parameter set 1: Standstill torque = 0
	1211	Motor rating plate: Parameter set 1: Max. torque = 0
	1212	Motor rating plate: Parameter set 1: Stator resistance = 0
	1213	Motor rating plate: Parameter set 1: Rotor inertia = 0
	1214	Motor rating plate: Parameter set 1: Pair of poles = 0
	1215	Motor rating plate: Parameter set 1: Temp. characteristic, R-reference = 0
	1216	Motor rating plate: Parameter set 1: Temp. characteristic, B-value = 0
	1217	Motor rating plate: Parameter set 1: Temp. characteristic, T-reference = 0
	1218	Motor rating plate: Parameter set 1: Proportional gain 2 = 0
	1219	Motor rating plate: Parameter set 1: Proportional gain 1 = 0
	1220	Motor rating plate: Parameter set 1: Integral action time 2 = 0
	1221	Motor rating plate: Parameter set 1: Integral action time 1 = 0
	1222	Motor rating plate: Parameter set 1: Torque constant value 1 = 0
	1223	Motor rating plate: Parameter set 1: EMF constant = 0
	1224	Motor rating plate: Parameter set 1: Series inductance = 0
	1225	Motor rating plate: Parameter set 1: Shunt inductance = 0
	1226	Motor rating plate: Parameter set 1: Rated voltage = 0
	1227	Motor rating plate: Parameter set 1: Noload current = 0
	1228	Motor rating plate: Parameter set 1: Rotor time constant = 0
	1229	Motor rating plate: Parameter set 1: LH char. curve: Lh-0 = 0
	1230	Motor rating plate: Parameter set 1: LH char. curve: Break point current = 0
	1231	Motor rating plate: Parameter set 1: LH char. curve: Lh saturation = 0
	1232	Motor rating plate: Parameter set 1: LH char. curve: Saturation current = 0
	1233	Motor rating plate: Parameter set 1: Leakage inductance stator = 0
	1234	Motor rating plate: Parameter set 1: Leakage inductance rotor = 0
	1235	Motor rating plate: Parameter set 1: Rotor resistance = 0
	1236	Motor rating plate: Parameter set 1: Temp. coefficient = 0
	1237	Motor rating plate: Parameter set 1: Version number < 3
	1238	Motor rating plate: Parameter set 1: 2nd winding not possible with Vecon
	1239	Motor rating plate: Parameter set 1: Encoder line count > 4096
	1240	Motor rating plate: Parameter set 1: Encoder line count > 4096
	1241	Motor rating plate: Parameter set 1: Software does not support motor/encoder type
	1242	Motor rating plate: Parameter set 1: Single-turn value = 0
	1243	Motor rating plate: Parameter set 1: Single-turn or multi-turn value = 0
1244	Motor rating plate: Parameter set 1: Signal periods between ref. marks = 0	
1246	Motor rating plate: Parameter set 1: Invalid motor type	
1250	Motor rating plate: Parameter set 1: Encoder type = 0	
1251	Motor rating plate: Parameter set 1: Pole pitch = 0	
1252	Motor rating plate: Parameter set 1: Speed: Nominal = 0	

VMA..KR, VMA..B,C,D,F and DM/DS error displays

F code display	Error number	Meaning
F70	1253	Motor rating plate: Parameter set 1: Speed: Maximum = 0
	1254	Motor rating plate: Parameter set 1: Force: Nominal thrust = 0
	1255	Motor rating plate: Parameter set 1: Force: Standstill thrust = 0
	1256	Motor rating plate: Parameter set 1: Force: Max. thrust = 0
	1257	Motor rating plate: Parameter set 1: Primary Resistance = 0
	1258	Motor rating plate: Parameter set 1: Transportable load = 0
	1259	Motor rating plate: Parameter set 1: Signal periods length = 0
	1260	Motor rating plate: Parameter set 1: Distance between reference marks = 0
	1261	Motor rating plate: Parameter set 1: Step distance = 0
	1262	Motor rating plate: Parameter set 1: Distance between reference marks = 0
	1263	Motor rating plate: Parameter set 1: Thrust constant value 1 = 0
	1264	Motor rating plate: Parameter set 1: EMF constant = 0
	1265	Motor rating plate: Parameter set 1: Series inductance = 0
	1266	Motor rating plate: Parameter set 1: Shunt inductance = 0
	1267	Motor rating plate: Parameter set 1: Leak inductance primary winding = 0
	1268	Motor rating plate: Parameter set 1: Leak inductance secondary winding=0
	1269	Motor rating plate: Parameter set 1: Second. resistance = 0
	1270	Multiturn value: Different rating plate info & Mfg. specifications; Motor set 1
	1271	Singleturn value: Different rating plate info & Mfg. specifications; Motor set 1
	1272	Encoder pulses: Different rating plate info & Mfg. specifications; Motor set 1
	1273	Singleturn value: Different rating plate info & Mfg. specifications; Motor set 1
	1274	Encoder pulses: Different rating plate info & Mfg. specifications; Motor set 1
	1275	No. of ref. marker periods:Different rating plate info & Mfg. specif.;Motor set1
	1276	Encoder pulses: Different rating plate info & Mfg. specifications; Motor set 1
	1277	Encoder pulses: Different rating plate info & Mfg. specifications; Motor set 1
	1278	Signal period length:Different rating plate info &Mfg. specifications;Motor set1
	1279	Steps distance : Different rating plate info & Mfg. specifications; Motor set 1
	1280	Signal period length:Different rating plate info& Mfg. specifications;Motor set1
	1281	Signal period length:Different rating plate info&Mfg. specifications;Motor set 1
	1282	Ref. marker spacing:Different rating plate info & Mfg. specifications;Motor set1
	1283	Signal period length:Different rating plate info &Mfg. specifications;Motor set1
	1284	Ref. marker spacing:Different rating plate info & Mfg. specifications;Motor set1
	1285	1st Ref. marker position:Different rating plate info & Mfg. specific.;Motor set1
	1286	Encoder pulses: Different rating plate info & Mfg. specifications; Motor set 1
1287	Encoder pulses: Different rating plate info & Mfg. specifications; Motor set 1	
1301	Motor rating plate: Parameter set 2: Motor type = 0	
1302	Motor rating plate: Parameter set 2: Version number = 0	
1303	Motor rating plate: Parameter set 2: Encoder pulses = 0	
1304	Motor rating plate: Parameter set 2: Nominal velocity = 0	

VMA..KR, VMA..B,C,D,F and DM/DS error displays

F code display	Error number	Meaning
	1305	Motor rating plate: Parameter set 2: Max. velocity = 0
	1306	Motor rating plate: Parameter set 2: Nominal current = 0
	1307	Motor rating plate: Parameter set 2: Standstill current = 0
	1308	Motor rating plate: Parameter set 2: Maximum current = 0
F70	1309	Motor rating plate: Parameter set 2: Rated torque = 0
	1310	Motor rating plate: Parameter set 2: Standstill torque = 0
	1311	Motor rating plate: Parameter set 2: Max. torque = 0
	1312	Motor rating plate: Parameter set 2: Stator resistance = 0
	1313	Motor rating plate: Parameter set 2: Rotor inertia = 0
	1314	Motor rating plate: Parameter set 2: Pair of poles = 0
	1315	Motor rating plate: Parameter set 2: Temp. characteristic, R-reference = 0
	1316	Motor rating plate: Parameter set 2: Temp. characteristic, B-value = 0
	1317	Motor rating plate: Parameter set 2: Temp. characteristic, T-reference = 0
	1318	Motor rating plate: Parameter set 2: Proportional gain 2 = 0
	1319	Motor rating plate: Parameter set 2: Proportional gain 1 = 0
	1320	Motor rating plate: Parameter set 2: Integral action time 2 = 0
	1321	Motor rating plate: Parameter set 2: Integral action time 1 = 0
	1322	Motor rating plate: Parameter set 2: Torque constant value 1 = 0
	1323	Motor rating plate: Parameter set 2: EMF constant = 0
	1324	Motor rating plate: Parameter set 2: Series inductance = 0
	1325	Motor rating plate: Parameter set 2: Shunt inductance = 0
	1326	Motor rating plate: Parameter set 2: Rated voltage = 0
	1327	Motor rating plate: Parameter set 2: Noload current = 0
	1328	Motor rating plate: Parameter set 2: Rotor time constant = 0
	1329	Motor rating plate: Parameter set 2: LH char. curve: Lh-0 = 0
	1330	Motor rating plate: Parameter set 2: LH char. curve: Break point current = 0
	1331	Motor rating plate: Parameter set 2: LH char. curve: Lh saturation = 0
	1332	Motor rating plate: Parameter set 2: LH char. curve: Saturation current = 0
	1333	Motor rating plate: Parameter set 2: Leakage inductance stator = 0
	1334	Motor rating plate: Parameter set 2: Leakage inductance rotor = 0
	1335	Motor rating plate: Parameter set 2: Rotor resistance = 0
	1336	Motor rating plate: Parameter set 2: Temp. coefficient = 0
	1337	Motor rating plate: Parameter set 2: Version number < 3
	1342	Motor rating plate: Parameter set 2: Single-turn value = 0
	1343	Motor rating plate: Parameter set 2: Single-turn or multi-turn value = 0
	1344	Motor rating plate: Parameter set 2: Signal periods between ref. Marks = 0
	1345	Motor rating plate: Encoder type not the same for parameter set 1 and 2
	1346	Motor rating plate: Parameter set 2: Invalid motor type
	1350	Motor rating plate: Parameter set 2: Encoder type = 0

VMA..KR, VMA..B,C,D,F and DM/DS error displays

F code display	Error number	Meaning
F70	1351	Motor rating plate: Parameter set 2: Pole pitch = 0
	1352	Motor rating plate: Parameter set 2: Speed: Nominal value = 0
	1353	Motor rating plate: Parameter set 2: Speed: Maximum = 0
	1354	Motor rating plate: Parameter set 2: Force: Nominal thrust = 0
	1355	Motor rating plate: Parameter set 2: Force: Standstill thrust = 0
	1356	Motor rating plate: Parameter set 2: Force: Max. thrust = 0
	1357	Motor rating plate: Parameter set 2: Primary Resistance = 0
	1358	Motor rating plate: Parameter set 2: Transportable load = 0
	1359	Motor rating plate: Parameter set 2: Signal periods length = 0
	1360	Motor rating plate: Parameter set 2: Distance between reference marks = 0
	1361	Motor rating plate: Parameter set 2: Step distance = 0
	1362	Motor rating plate: Parameter set 2: Distance between reference marks = 0
	1363	Motor rating plate: Parameter set 2: Thrust constant value 1 = 0
	1364	Motor rating plate: Parameter set 2: EMF constant = 0
	1365	Motor rating plate: Parameter set 2: Series inductance = 0
	1366	Motor rating plate: Parameter set 2: Shunt inductance = 0
	1367	Motor rating plate: Parameter set 2: Leakage inductance primary winding = 0
	1368	Motor rating plate: Parameter set 2: Leakage inductance secondary winding = 0
	1369	Motor rating plate: Parameter set 2: Second. resistance = 0
	1370	Multiturn value: Different rating plate info & Mfg. specifications; Motor set 2
	1371	Singleturn value: Different rating plate info & Mfg. specifications; Motor set 2
	1372	Encoder pulses: Different rating plate info & Mfg. specifications; Motor set 2
	1373	Singleturn value: Different rating plate info & Mfg. specifications; Motor set 2
	1374	Encoder pulses: Different rating plate info & Mfg. specifications; Motor set 2
	1375	No. of ref. marker periods: Different rating plate info <-> Mfg. specs; Motor set 2
	1376	Encoder pulses: Different rating plate info & Mfg. specifications; Motor set 2
	1377	Encoder pulses: Different rating plate info & Mfg. specifications; Motor set 2
	1378	Signal period length: Different rating plate info & Mfg. specifications; Motor set 2
	1379	Steps distance : Different rating plate info & Mfg. specifications; Motor set 2
	1380	Signal period length: Different rating plate info & Mfg. specifications; Motor set 2
	1381	Signal period length: Different rating plate info & Mfg. specifications; Motor set 2
	1382	Ref. marker spacing: Different rating plate info & Mfg. specifications; Motor set 2
	1383	Signal period length: Different rating plate info & Mfg. specifications; Motor set 2
1384	Ref. marker spacing: Different rating plate info & Mfg. specifications; Motor set 2	
1385	1st Ref. marker position: Different rating plate info & Mfg. specs; Motor set 2	
1386	Encoder pulses: Different rating plate info & Mfg. specifications; Motor set 2	
1387	Encoder pulses: Different rating plate info & Mfg. specifications; Motor set 2	
2201	Flash rating plate: Parameter set 1: Motor type = 0	
2202	Flash rating plate: Parameter set 1: Version number = 0	

VMA..KR, VMA..B,C,D,F and DM/DS error displays

F code display	Error number	Meaning
F70	2203	Flash rating plate: Parameter set 1: Encoder pulses = 0
	2204	Flash rating plate: Parameter set 1: Nominal velocity = 0
	2205	Flash rating plate: Parameter set 1: Max. velocity = 0
	2206	Flash rating plate: Parameter set 1: Nominal current = 0
	2207	Flash rating plate: Parameter set 1: Standstill current = 0
	2208	Flash rating plate: Parameter set 1: Maximum current = 0
	2209	Flash rating plate: Parameter set 1: Rated torque = 0
	2210	Flash rating plate: Parameter set 1: Standstill torque = 0
	2211	Flash rating plate: Parameter set 1: Max. torque = 0
	2212	Flash rating plate: Parameter set 1: Stator resistance = 0
	2213	Flash rating plate: Parameter set 1: Rotor inertia = 0
	2214	Flash rating plate: Parameter set 1: Pair of poles = 0
	2215	Flash rating plate: Parameter set 1: Temp. characteristic, R-reference = 0
	2216	Flash rating plate: Parameter set 1: Temp. characteristic, B-value = 0
	2217	Flash rating plate: Parameter set 1: Temp. characteristic, T-reference = 0
	2218	Flash rating plate: Parameter set 1: Proportional gain 2 = 0
	2219	Flash rating plate: Parameter set 1: Proportional gain 1 = 0
	2220	Flash rating plate: Parameter set 1: Integral action time 2 = 0
	2221	Flash rating plate: Parameter set 1: Integral action time 1 = 0
	2222	Flash rating plate: Parameter set 1: Torque constant value 1 = 0
	2223	Flash rating plate: Parameter set 1: EMF constant = 0
	2224	Flash rating plate: Parameter set 1: Series inductance = 0
	2225	Flash rating plate: Parameter set 1: Shunt inductance = 0
	2226	Flash rating plate: Parameter set 1: Rated voltage = 0
	2227	Flash rating plate: Parameter set 1: Noload current = 0
	2228	Flash rating plate: Parameter set 1: Rotor time constant = 0
	2229	Flash rating plate: Parameter set 1: LH char. curve: Lh-0 = 0
	2230	Flash rating plate: Parameter set 1: LH char. curve: Break point current = 0
	2231	Flash rating plate: Parameter set 1: LH char. curve: Lh saturation = 0
	2232	Flash rating plate: Parameter set 1: LH char. curve: Saturation current = 0
	2233	Flash rating plate: Parameter set 1: Leakage inductance stator = 0
	2234	Flash rating plate: Parameter set 1: Leakage inductance rotor = 0
	2235	Flash rating plate: Parameter set 1: Rotor resistance = 0
2236	Flash rating plate: Parameter set 1: Temp. coefficient = 0	
2237	Flash rating plate: Parameter set 1: Version number < 3	
2238	Flash rating plate: Parameter set 1: 2nd winding not possible with Vecon	
2239	Flash rating plate: Parameter set 1: Encoder line count > 4096	
2240	Flash rating plate: Parameter set 1: Encoder line count > 4096	
2241	Flash rating plate: Parameter set 1: Software does not support motor/encoder type	

VMA..KR, VMA..B,C,D,F and DM/DS error displays

F code display	Error number	Meaning
F70	2242	Flash rating plate: Parameter set 1: Single-turn value = 0
	2243	Flash rating plate: Parameter set 1: Single-turn or multi-turn value = 0
	2244	Flash rating plate: Parameter set 1: Signal periods between ref. marks = 0
	2246	Flash rating plate: Parameter set 1: Invalid motor type
	2250	Flash rating plate: Parameter set 1: Encoder type = 0
	2251	Flash rating plate: Parameter set 1: Pole pitch = 0
	2252	Flash rating plate: Parameter set 1: Speed: Nominal value = 0
	2253	Flash rating plate: Parameter set 1: Speed: Maximum = 0
	2254	Flash rating plate: Parameter set 1: Force: Nominal thrust = 0
	2255	Flash rating plate: Parameter set 1: Force: Standstill thrust = 0
	2256	Flash rating plate: Parameter set 1: Force: Max. thrust = 0
	2257	Flash rating plate: Parameter set 1: Primary Resistance = 0
	2258	Flash rating plate: Parameter set 1: Transportable load = 0
	2259	Flash rating plate: Parameter set 1: Signal periods length = 0
	2260	Flash rating plate: Parameter set 1: Distance between reference marks = 0
	2261	Flash rating plate: Parameter set 1: Step distance = 0
	2262	Flash rating plate: Parameter set 1: Distance between reference marks = 0
	2263	Flash rating plate: Parameter set 1: Thrust constant value 1 = 0
	2264	Flash rating plate: Parameter set 1: EMK constant = 0
	2265	Flash rating plate: Parameter set 1: Series inductance = 0
	2266	Flash rating plate: Parameter set 1: Shunt inductance = 0
	2267	Flash rating plate: Parameter set 1: Leakage inductance, primary winding=0
	2268	Flash rating plate: Parameter set 1: Leakage inductance, secondary winding=0
	2269	Flash rating plate: Parameter set 1: Second. resistance = 0
	2301	Flash rating plate: Parameter set 2: Motor type = 0
	2302	Flash rating plate: Parameter set 2: Version number = 0
	2303	Flash rating plate: Parameter set 2: Encoder pulses = 0
	2304	Flash rating plate: Parameter set 2: Nominal velocity = 0
	2305	Flash rating plate: Parameter set 2: Max. velocity = 0
	2306	Flash rating plate: Parameter set 2: Nominal current = 0
	2307	Flash rating plate: Parameter set 2: Standstill current = 0
	2308	Flash rating plate: Parameter set 2: Maximum current = 0
	2309	Flash rating plate: Parameter set 2: Rated torque = 0
	2310	Flash rating plate: Parameter set 2: Standstill torque = 0
2311	Flash rating plate: Parameter set 2: Max. torque = 0	
2312	Flash rating plate: Parameter set 2: Stator resistance = 0	
2313	Flash rating plate: Parameter set 2: Rotor inertia = 0	
2314	Flash rating plate: Parameter set 2: Pair of poles = 0	
2315	Flash rating plate: Parameter set 2: Temp. characteristic, R-reference = 0	

VMA..KR, VMA..B,C,D,F and DM/DS error displays



F code display	Error number	Meaning
F70	2316	Flash rating plate: Parameter set 2: Temp. characteristic, B-value = 0
	2317	Flash rating plate: Parameter set 2: Temp. characteristic, T-reference = 0
	2318	Flash rating plate: Parameter set 2: Proportional gain 2 = 0
	2319	Flash rating plate: Parameter set 2: Proportional gain 1 = 0
	2320	Flash rating plate: Parameter set 2: Integral action time 2 = 0
	2321	Flash rating plate: Parameter set 2: Integral action time 1 = 0
	2322	Flash rating plate: Parameter set 2: Torque constant value 1 = 0
	2323	Flash rating plate: Parameter set 2: EMF constant = 0
	2324	Flash rating plate: Parameter set 2: Series inductance = 0
	2325	Flash rating plate: Parameter set 2: Shunt inductance = 0
	2326	Flash rating plate: Parameter set 2: Rated voltage = 0
	2327	Flash rating plate: Parameter set 2: Noload current = 0
	2328	Flash rating plate: Parameter set 2: Rotor time constant = 0
	2329	Flash rating plate: Parameter set 2: LH char. curve: Lh-0 = 0
	2330	Flash rating plate: Parameter set 2: LH char. curve: Break point current = 0
	2331	Flash rating plate: Parameter set 2: LH char. curve: Lh saturation = 0
	2332	Flash rating plate: Parameter set 2: LH char. curve: Saturation current = 0
	2333	Flash rating plate: Parameter set 2: Leakage inductance stator = 0
	2334	Flash rating plate: Parameter set 2: Leakage inductance rotor = 0
	2335	Flash rating plate: Parameter set 2: Rotor resistance = 0
	2336	Flash rating plate: Parameter set 2: Temp. coefficient = 0
	2337	Flash rating plate: Parameter set 2: Version number < 3
	2342	Flash rating plate: Parameter set 2: Single-turn value = 0
	2343	Flash rating plate: Parameter set 2: Single-turn or multi-turn value = 0
	2344	Flash rating plate: Parameter set 2: Signal periods between ref. marks = 0
	2345	Flash rating plate: Encoder type not the same for parameter set 1 and 2
	2346	Flash rating plate: Parameter set 2: Invalid motor type
	2350	Flash rating plate: Parameter set 2: Encoder type = 0
	2351	Flash rating plate: Parameter set 2: Pole pitch = 0
	2352	Flash rating plate: Parameter set 2: Speed: Nominal value = 0
	2353	Flash rating plate: Parameter set 2: Speed: Maximum = 0
	2354	Flash rating plate: Parameter set 2: Force: Nominal thrust = 0
	2355	Flash rating plate: Parameter set 2: Force: Standstill thrust = 0
2356	Flash rating plate: Parameter set 2: Force: Max. thrust = 0	
2357	Flash rating plate: Parameter set 2: Primary Resistance = 0	
2358	Flash rating plate: Parameter set 2: Transportable load = 0	
2359	Flash rating plate: Parameter set 2: Signal periods length = 0	
2360	Flash rating plate: Parameter set 2: Distance between reference marks = 0	
2361	Flash rating plate: Parameter set 2: Step distance = 0	

VMA..KR, VMA..B,C,D,F and DM/DS error displays

F code display	Error number	Meaning
F70	2362	Flash rating plate: Parameter set 2: Distance between reference marks = 0
	2363	Flash rating plate: Parameter set 2: Thrust constant value 1 = 0
	2364	Flash rating plate: Parameter set 2: EMF constant = 0
	2365	Flash rating plate: Parameter set 2: Series inductance = 0
	2366	Flash rating plate: Parameter set 2: Shunt inductance = 0
	2367	Flash rating plate: Parameter set 2: Leakage inductance primary winding = 0
	2368	Flash rating plate: Parameter set 2: Leakage inductance secondary winding = 0
	2369	Flash rating plate: Parameter set 2: Second. resistance = 0
F71	0	Inverter-Initialization error – Detailed fault documentation unavailable at this
F72	0	Configuration error; Motor / module combination not functional
F91	0	Personality error; Check proper seating of PM; Replace module
F92	0	I2C-Bus runtime error; Defective module
F95	0	I-controller synchronization error; Defective module
F96	0	Speed controller, plausibility error – Detailed fault documentation unavailable
	2	Drive blocked in negative direction
	3	Too little current → Performance interruption
	4	Motor overspeed → Reverse acceleration
	5	Too little current → Performance interruption
	8	Timeout torque limitation
	18	Drive blocked in positive direction
	19	Too little current → Performance interruption
	20	Motor overspeed → Reverse acceleration
	21	Too little current → Performance interruption
	128	Speed controller synchronization error
F97	0	VM shutdown due to FGZ shutdown
F98	0	ASTS shutdown

PROFIBUS-DP errors

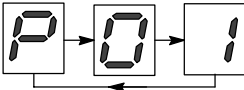
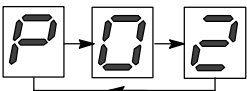
4.6 PROFIBUS-DP errors

Displays flash alternately.	Error	Action
	<p>The drive has switched off.</p>	
	<p>Initialization error Incorrect parameterization data</p>	<ul style="list-style-type: none"> • Check structure of the parameterization data (refer to “Servodyn with PROFIBUS-DP Interface” manual)
	<p>Initialization error Configuration data does not match the desired configuration</p>	<ul style="list-style-type: none"> • Check whether the drive mode from the parameterization data matches the telegram configuration

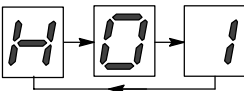
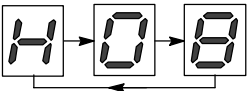
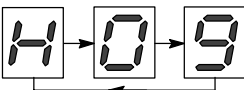
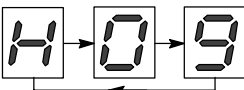
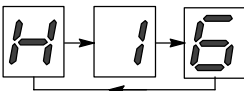

4.7 DMA computer errors (without SERCOS interface)

Displays flash alternately.	Error	Action
	<p>The drive has switched off.</p>	
 <p>up to</p> 	<p>CPU program execution errors</p> <p>H01 dc Power failure (also refer to F 36) H02 stack overflow H03 stack underflow H04 undefined CPU code H05 undefined protected command H06 inadmissible word instruction H07 inadmissible jump H08 inadmissible bus control</p>	<ul style="list-style-type: none"> • Contact Rexroth technical service • Replace module
 <p>up to</p> 	<p>CPU computing errors</p> <p>H09 integer overflow H10 floating overflow H11 floating underflow H12 division by zero H13 undefined floating number H14 integer/floating conversion error H15 floating point stack overflow H16 floating point stack underflow</p>	<ul style="list-style-type: none"> • Check last parameter changes made before error occurred • Contact Rexroth technical service

Servodyn-D frequency inverter displays

4.8 Servodyn-D frequency inverter displays

4.8.1 Status/warning displays

LED	Status	Action
 FG	Axis enable external if <ul style="list-style-type: none"> • 24 V at X06.3/4 (FG) 	—
 FGI	Enable internal if <ul style="list-style-type: none"> • 24 V at X06.3 (FG) • Central enable by VM present • no error 	—

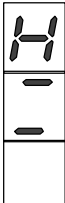

3-digit 7-segment display

 <p>computer has been booted TEMP STA</p>	<p>Operating display:</p> <ul style="list-style-type: none"> • STA is present if: <ul style="list-style-type: none"> – computer has been booted – no errors <p>Temperature status:</p> <ul style="list-style-type: none"> • TEMP is present if: Temperature of the heat sink or the motor (with active bimetal function) is within the permitted range. • TEMP relay is closed 	<p>—</p> <p>If no display (temperature exceeded):</p> <ul style="list-style-type: none"> • Check air supply, fan • Reduce cycle frequency or load • Select motor with higher rating • Verify bimetal setting
---	--	--

You can read various operating data from the 7-segment display:

- Press <D> key in the basic display.
- Select the 'A' display function with the <↑> or <↓> keys.
- Press key <D>.
- Select the desired operating display with the <↑> or <↓> keys, e.g. A00 (actual output frequency).
- Press key <D>.
- The display shows the current operating data.
- Jump back to the operating data level by simultaneously pressing the <↑> and <↓> keys.
- You may now select the next operating display with the <↑> or <↓> keys, e.g. A08.
- Further procedure as described above.

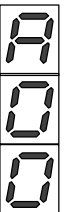









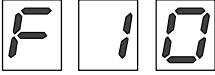

Servodyn-D frequency inverter displays



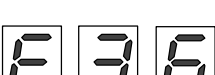

	Read from DSS	Unit	Description	
A00	A-0-1000	Hz	Actual output frequency f_{act}	Current motor frequency
A01	A-0-1001	Hz	Commanded output frequency f_{set}	Specified output frequency
A02	A-0-1002	A	Total current	rms value of the total current
A03	A-0-1003	A	Active current	rms value of active current
A04	A-0-1004	A	Reactive current	rms value of reactive current
A05	A-0-1005	V	Motor voltage	rms value of current motor voltage
A06	A-0-1006	V	DC link voltage	Current value of DC link voltage (display = 350 V for voltage values ≤ 350 V)
A07	A-0-1007	kVA	Total power	Current total power
A08	A-0-1008	kW	Shaft output	Current mechanical shaft output of the motor
A09	A-0-1009	%	Utilization	Current utilization of the motor, for $f < f_N$ with reference to the motor torque M_N for $f > f_N$ with reference to the motor power P_N Accuracy: depends on the motor, for $n > 0.1 n_N$ approx. 5% of the final value
A10	A-0-1010	°C	Heat sink temperature	Current heat sink temperature. With increased heat sink temperature: Warning 'U01', TEMP relay is opened.
A11	A-0-1011	A	Present current limit	The presently effective current limit is set depending on the selected settings and the current heat sink temperature.
A12	A-0-1012		TEMP warning	Warning message when TEMP relay has switched off:
			U00	no warning
			U01	excessive heat sink temperature
			U02	Excessive motor temperature. Only if bimetal function is active P43 – P45.
			U03	Excessive heat sink and motor temperature
A13	A-0-1013		Last error after STA shut-off	After restart, the last error present before STA was deactivated is displayed.
A14	A-0-1014		Software version	Number left of point = software status Number right of point = software scope. Please indicate this data in the event of enquiries.
A15	A-0-1015		Software index	Version index of operating software, always specify in enquiries.

Servodyn-D frequency inverter displays

4.8.2 Error displays

Displays in vertical arrangement on the module	Error	Action
	The drive has switched off.	
	Power supply fault Internal or external 24 V supply voltages not in admissible range	<ul style="list-style-type: none"> • Check module cross-connection • Replace module
	Overvoltage / Driver fault Power output stage was switched off because of a fault in the power supply unit	<ul style="list-style-type: none"> • Check output stage • Replace module
	Short-circuit or ground fault in the load circuit Motor or motor cable defective	<ul style="list-style-type: none"> • Measure motor and motor lead • Check output stage
	Overcurrent Admissible module peak current exceeded for > 2 sec	<ul style="list-style-type: none"> • Reduce load • Select flatter braking and acceleration ramps • Check application
	Overvoltage in DC link $U_{DC} > 860 \text{ V}$, unless F20	<ul style="list-style-type: none"> • Check system voltage • Reduce braking power
	Motor connection Motor not properly connected	<ul style="list-style-type: none"> • Check motor connection
	Heat sink overtemperature	<ul style="list-style-type: none"> • Check air supply • Check fan
	Motor overtemperature Electronic bimetal function signals motor overload	<ul style="list-style-type: none"> • Verify bimetal setting • Check motor rating
	Motor overtemperature PTC connection signals motor overload	<ul style="list-style-type: none"> • Check motor rating
	Signal cross-connection (computer driver) Hardware fault	<ul style="list-style-type: none"> • Replace module
	Signal cross-connection (computer driver) Runtime error	<ul style="list-style-type: none"> • Replace module

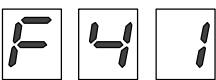
Servodyn-D frequency inverter displays

Displays in vertical arrangement on the module	Error The drive has switched off.	Action
 to 	Driver fault Invalid driver parameter	<ul style="list-style-type: none"> • Replace module
	Error in RAM memory	<ul style="list-style-type: none"> • Replace module
	EEPROM error EEPROM cannot be read/written	<ul style="list-style-type: none"> • Replace module
 to 	Real-time error Processor error	<ul style="list-style-type: none"> • Restart module • Replace module

Connection overview

5 Connection overview

5.1 VMA..KB, VMA..KE supply module (with ballast switch)

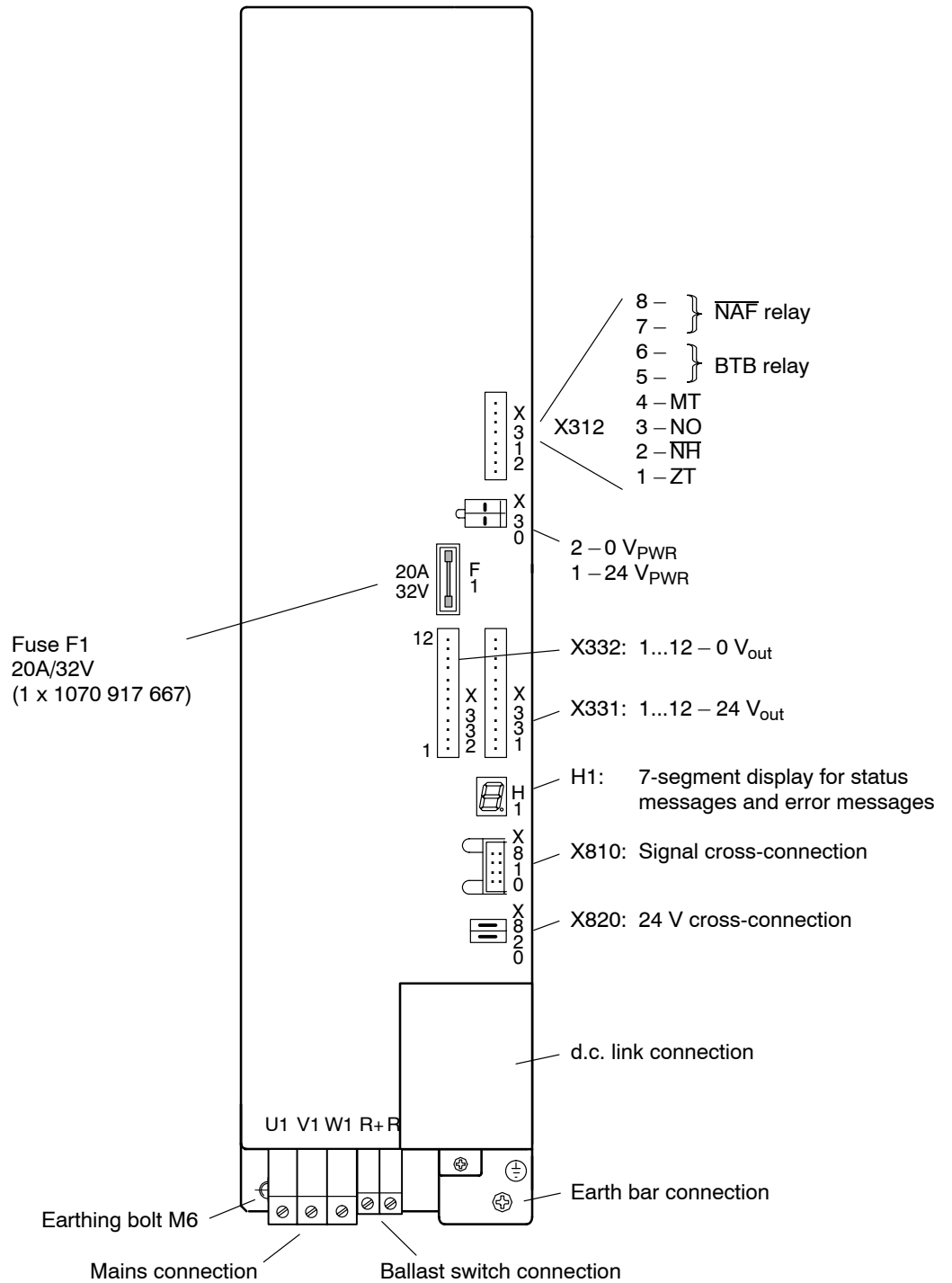

Connection overview

5.2 VMA..KR, VMA..B,C,D,F supply module (with current regeneration)

Figure shows VMA 35B, interface is identical for all modules

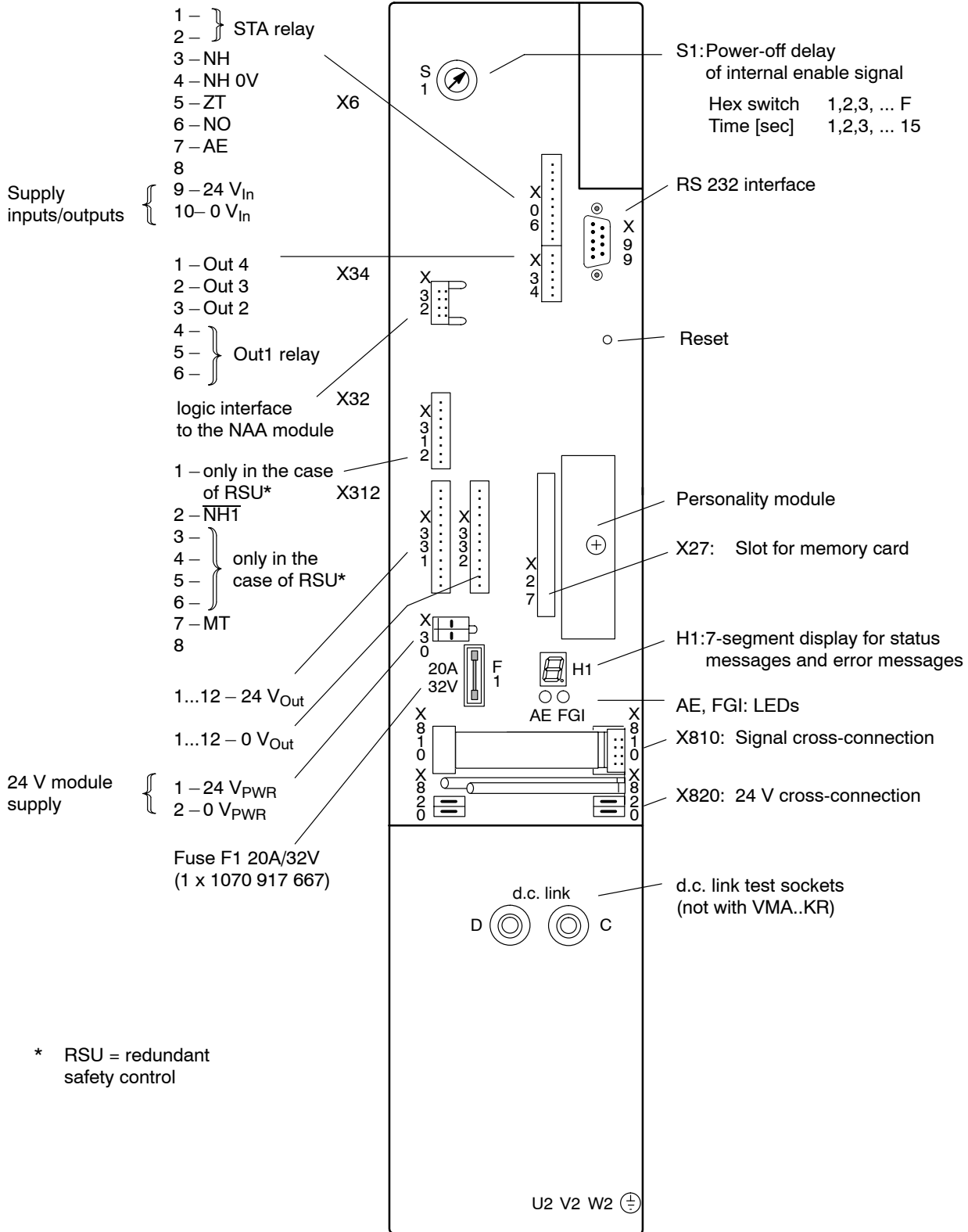

* RSU = redundant safety control

Connection overview

5.3 DMA module with analog interface or positioning function (MC)

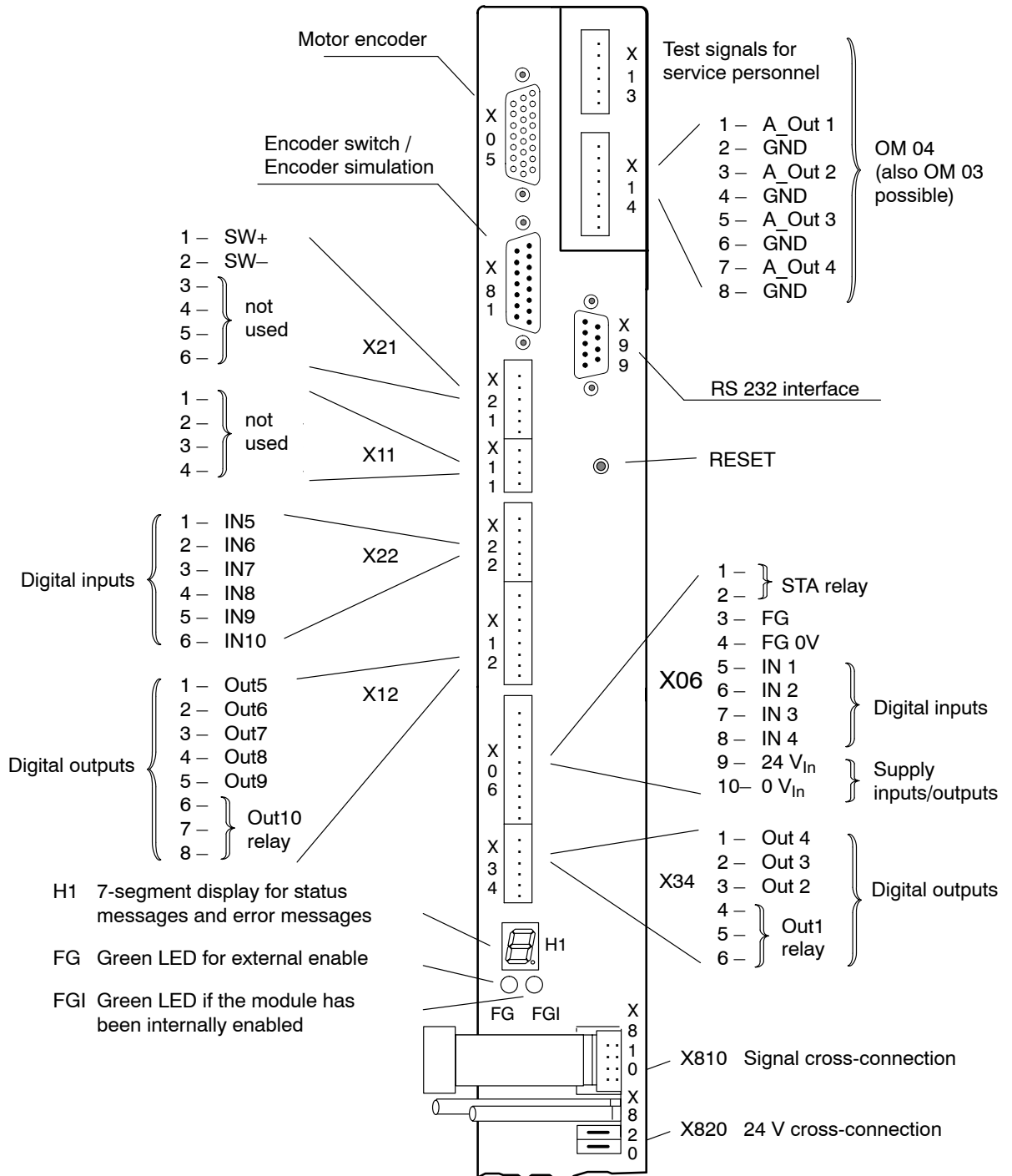

Connection overview

5.4 DMA module with SERCOS interface

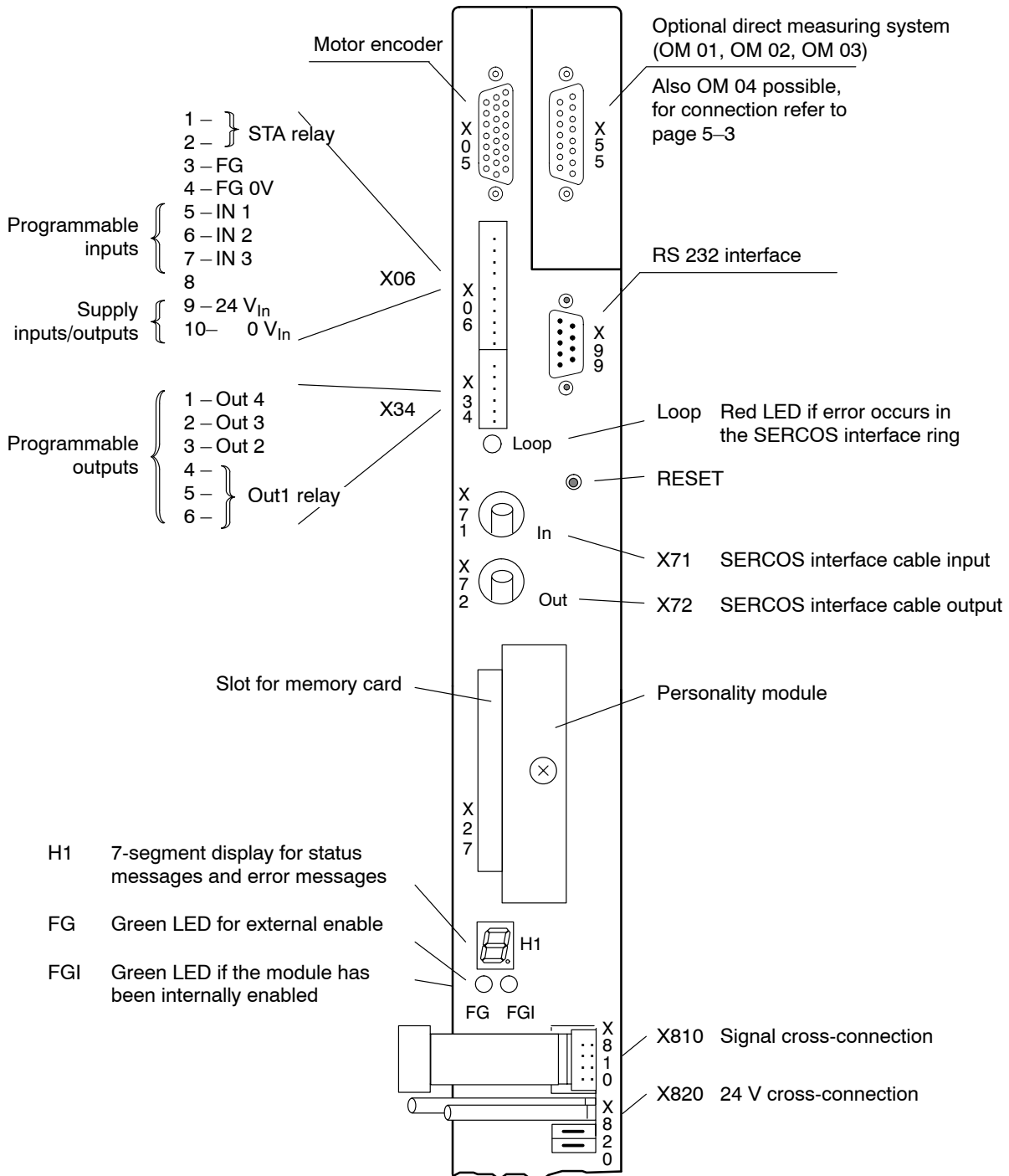

DANGER

Do not look directly into the LEDs in the optical fiber connection. Due to their high output, this may result in eye injuries. When the inverter is switched on, do not look into the LED or the open end of a short connected lead.

Connection overview

5.5 DMA module with CAN bus

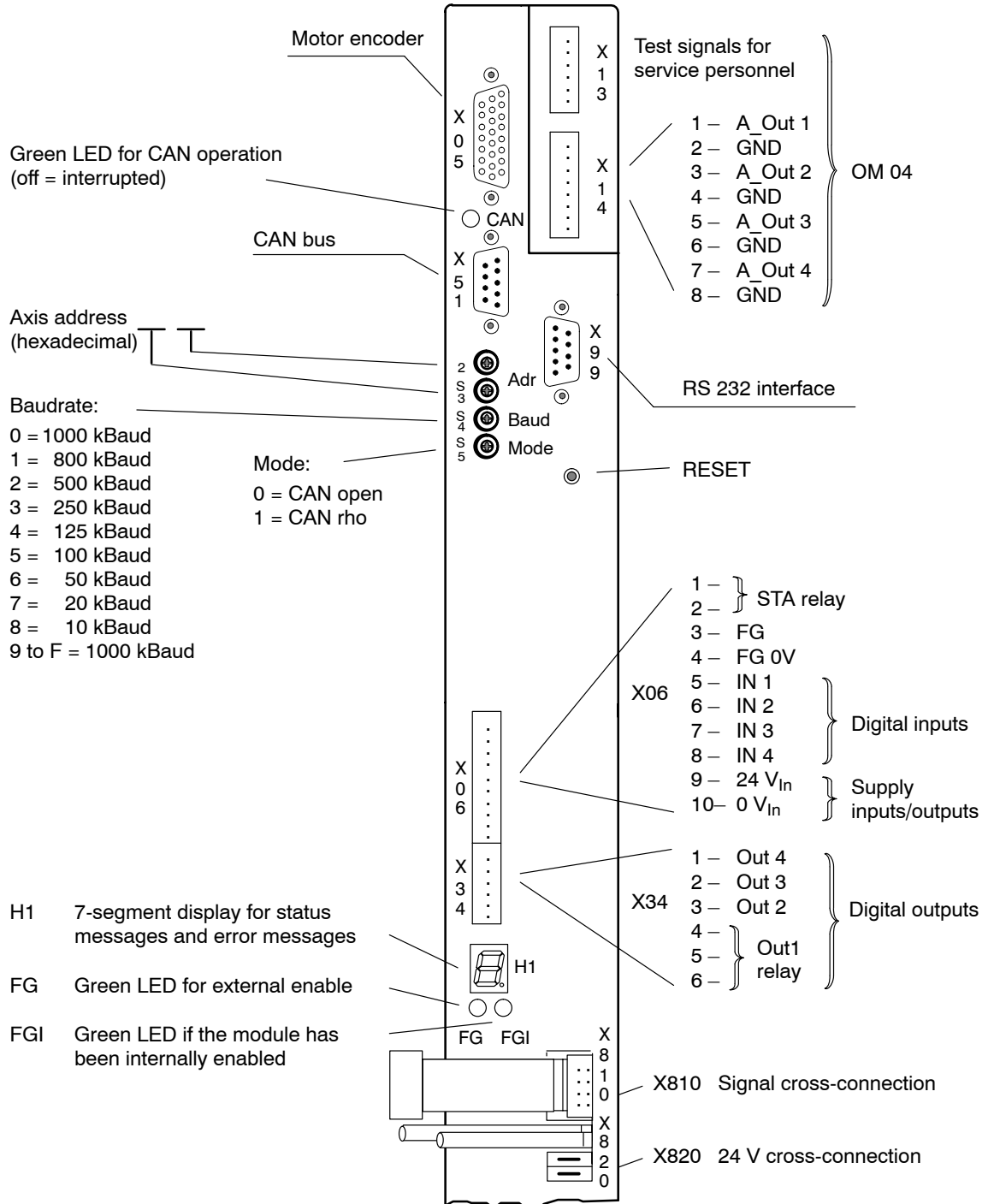

Connection overview

5.6 DMA module with PROFIBUS-DP

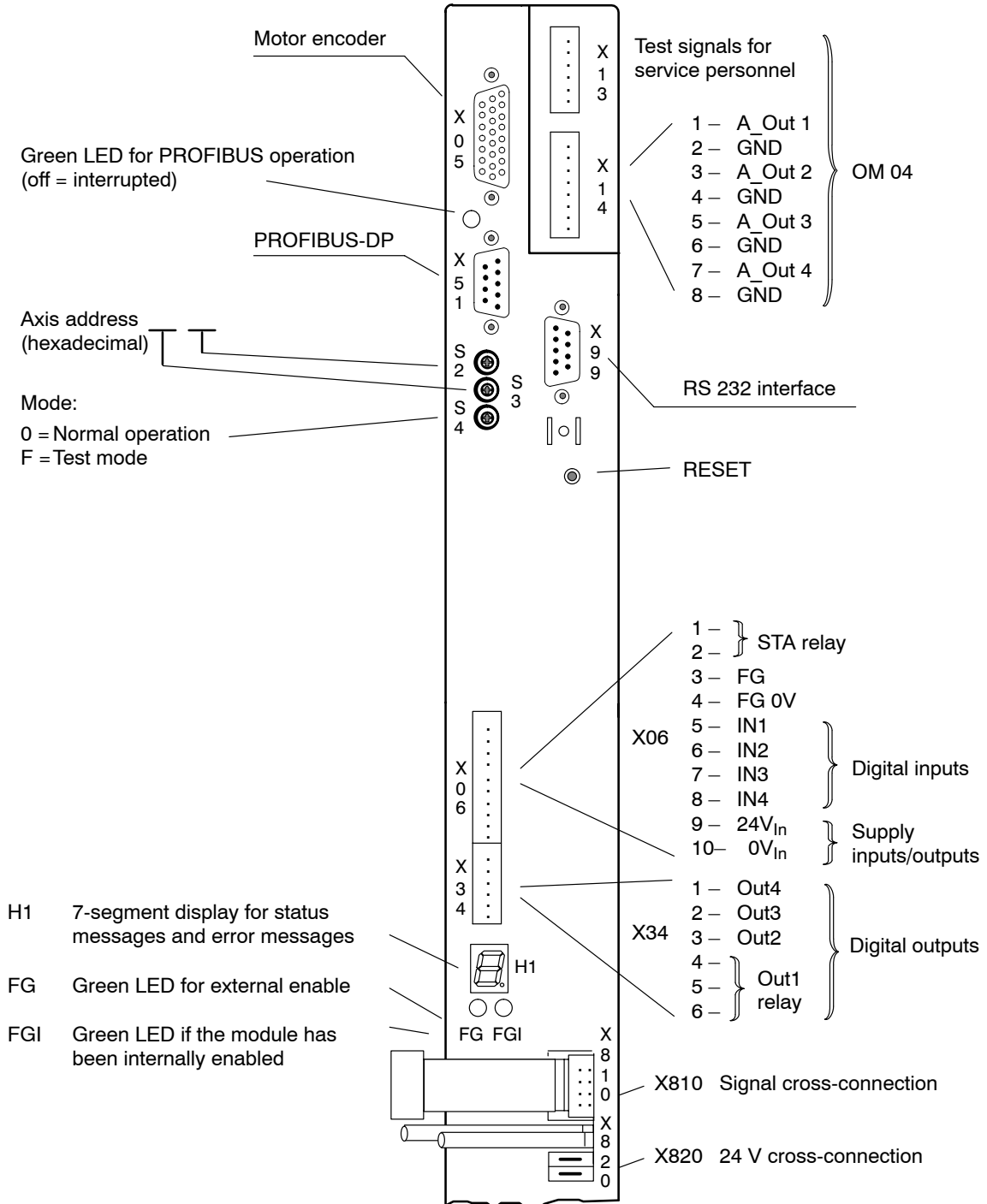

Connection overview

5.7 DM..8001-D frequency inverter with analog interface

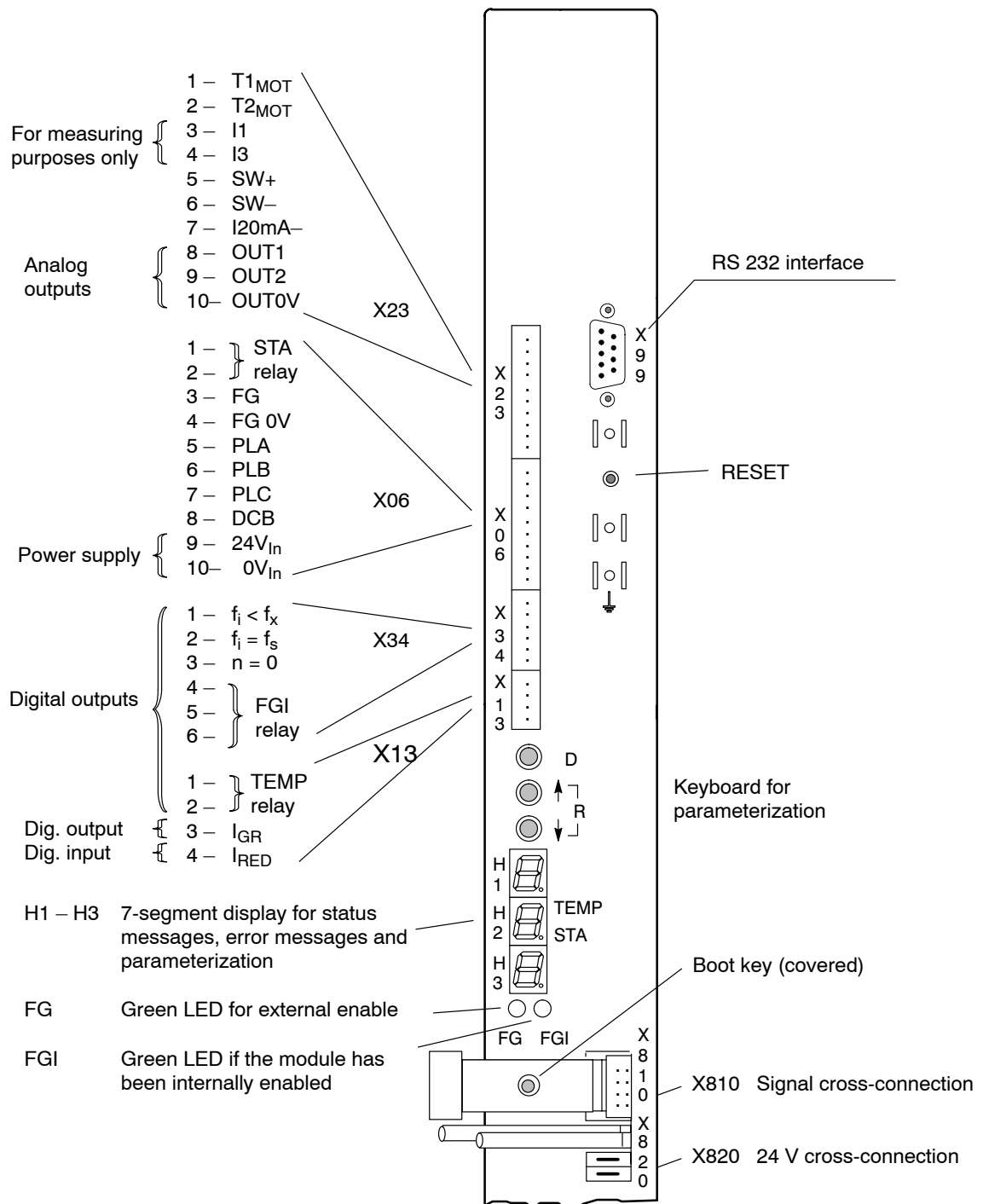

Connection overview

5.8 Stand-alone module DS, supply unit

Stand-alone modules are single-axis drives with an integrated supply unit. The interfaces and functions correspond to those of the modules described in sections 5.3 to 5.7. Therefore, the following illustration only shows the additional connectors of the supply unit:

5.8.1 Overview of DS..K xxx2-D (in set-up mode)

Other connectors corresponding to the interfaces:

- analog interface, positioning function
- frequency inverter
- CAN bus
- SERCOS interface
- PROFIBUS-DP

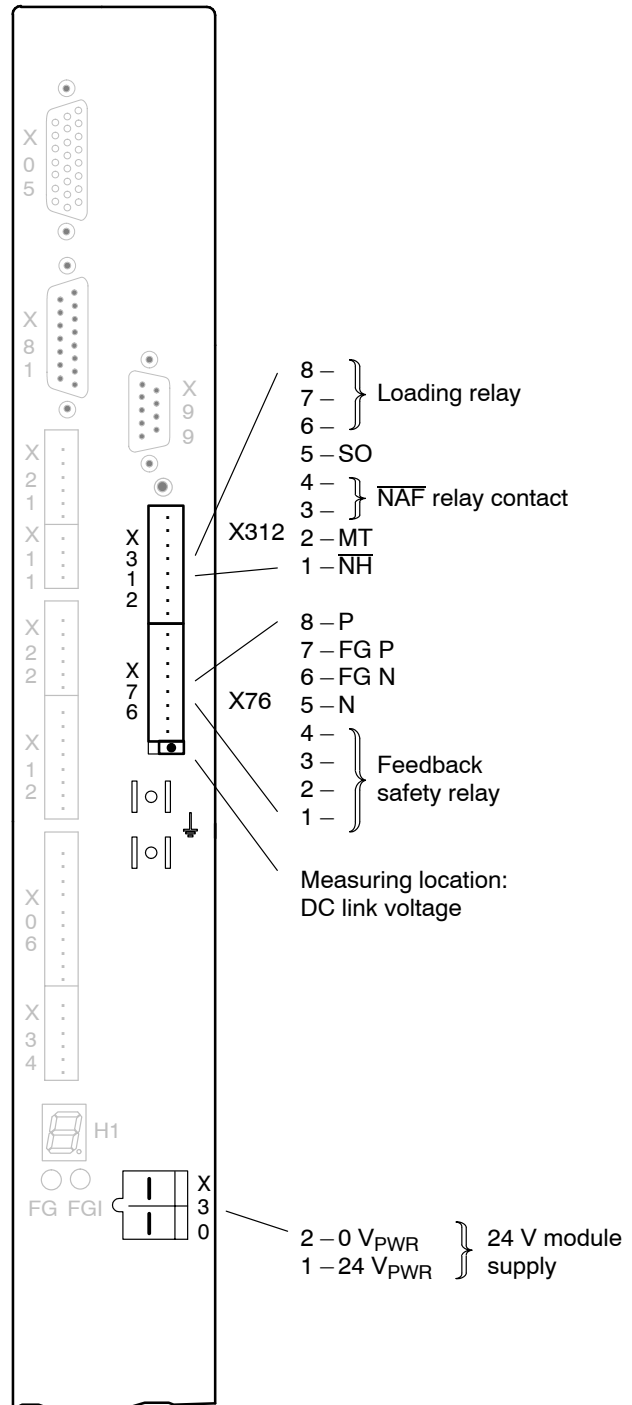

Connection overview

5.9 Overview of DS..K xxx1-D

- Other connectors corresponding to the interfaces:
- analog interface, positioning function
 - frequency inverter
 - CAN bus
 - SERCOS interface
 - PROFIBUS-DP

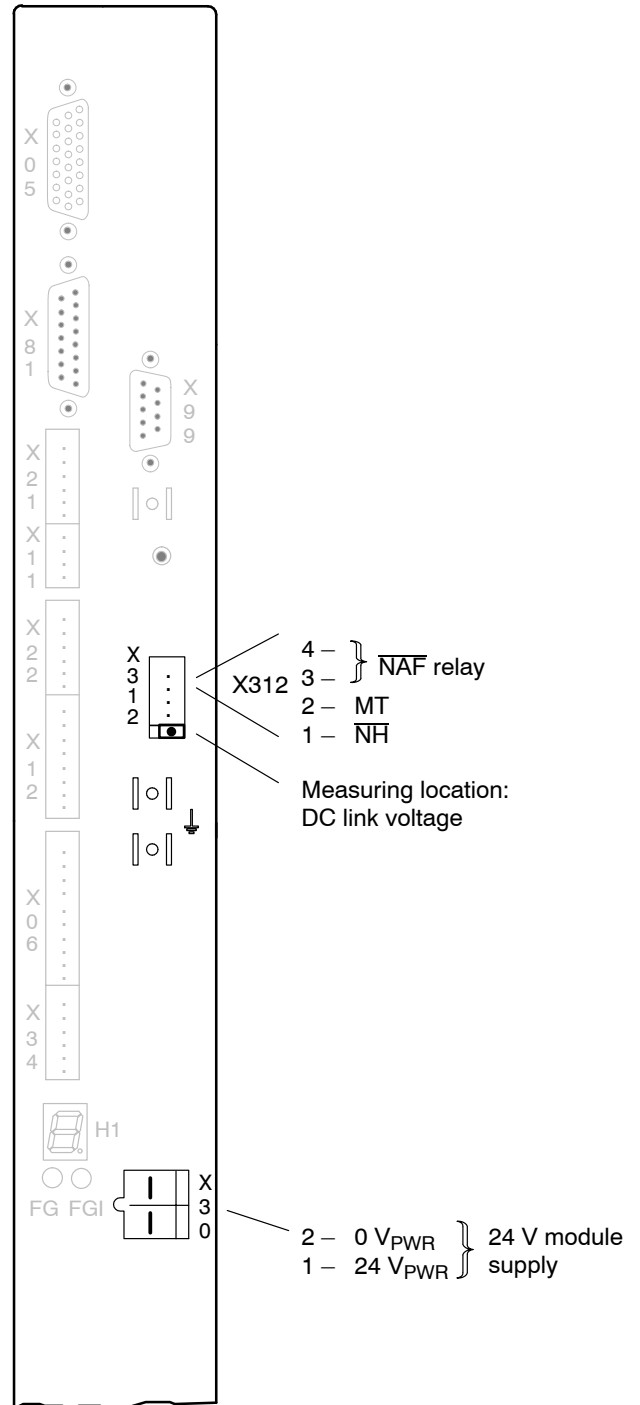

Connection overview

Notes:

Replacing components

6 Replacing components

**DANGER**

Danger caused by unqualified interventions.

The maintenance and installation of the components is reserved to qualified personnel who observes the accident prevention regulations (UVV VBG4, VDE 100, VDE 105) and installation standards (EN 60204-Part 1, prEN 50178).

Please note the safety instructions on the first pages of this manual!

6.1 Motors

**DANGER**

Brakes are subject to wear.

The holding brake is no service brake and must only be operated when the axis is at standstill.

After approx. 1000 Emergency-Stop braking processes with an extraneous moment of inertia \leq motor moment of inertia, the holding brake must be checked in the manufacturer's workshop.

**DANGEROUS ELECTRICAL VOLTAGE**

All connection and installation work must be performed while the system is de-energized.

Due to permanent magnet excitation, a dangerous voltage is present at the power outlet when the rotor is rotating and the motor is not connected electrically!

**DANGER**

Danger of injuries by ejected featherkey.

Motors with a groove and featherkey may only be operated when installed in place or with featherkey secured.

**CAUTION**

Damages to the module or inverter by removing plug-in connections.

All plug-in connections to the encoder may only be inserted or removed while the drive is switched off.

Replacing components



CAUTION

Impacts and shocks applied to the shaft end will damage the rotary encoder and ball bearings!

Drive elements such as pulleys, clutch disks, toothed wheels etc. may only be assembled or removed by continuously heating up the drive elements or with a suitable installation or removal tool. Use the thread in the shaft end.

At least half of motors with an **oil-tight flange on the output side** (oil-running tight, designs 100, 101) must be submerged in oil. Due to the high friction, they must never be started dry.

For dry operation, the rotary shaft seal must be removed, however, it cannot be reinstalled afterwards.



CAUTION

Loss of data!

Interventions in the motor may delete the data of the electronic rating plate.

Do not dismantle servo motors. Installation work in excess of the adjustment of the outgoing cable direction must be performed in the manufacturer's workshop.

The outgoing direction of all plug-in systems can be changed by releasing the angle flange box.

Do not turn the angle flange box by more than 180° in order to avoid damaging the connection leads.



CAUTION

Moisture inside the motor.

When tightening the angle flange box, please make sure that the O-ring is properly seated in the groove of the angle flange box.

Protection standard IP 67 is achieved for the plug-in system only if the admissible external lead diameters are maintained and the mating connectors are screwed down to their stop.

Replacing components

6.2 Drive modules



CAUTION

Destruction of power units!

Note the tightening torque of 3 Nm for the power connections U, V, W.

6.2.1 VM...K and DM...K

The DC link connection is achieved with conductor bars "C" and "D" at the front side of the modules:

1. Release fastening screw below the cover, unhinge and remove cover upward.
2. Release screws of the pre-assembled conductor bars, push bars below the fastening screws of the adjoining left module, and tighten screws again.

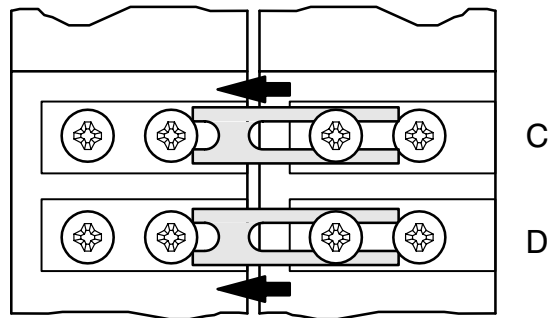

CAUTION

Destruction of power units!

Please note the tightening torque of 3 Nm for the screwed DC link connections.

3. Reinststate all covers.



DANGEROUS ELECTRICAL VOLTAGE

Busbars carry lethal voltages during operation.

It is absolutely necessary to install the shock-protection covers at both ends of each row of modules.

Replacing components

6.2.2 DC link connection of VMA..B,C,D and DMA..A,B,D with backplane modules

The conductor bars are captivated in the backplane module terminal blocks.

Mounting using a SW 4 Allen key:

1. Unscrew the terminal screws (1).
2. Unscrew the terminal screws (2), move the conductor bars into the adjoining terminal block and tighten the screws.
3. Fasten the second end of the conductor bar using the terminal screw (1).
4. Cover the right backplane module terminal block of every module row with the terminal block end cover from the VMA module accessory set. There is a second cover in the DC link terminal accessory set which can be used if there are two module rows.



DANGEROUS ELECTRICAL VOLTAGE

Busbars carry lethal voltages during operation.

It is absolutely necessary to install the terminal block covers at the right-hand end of each row of modules.

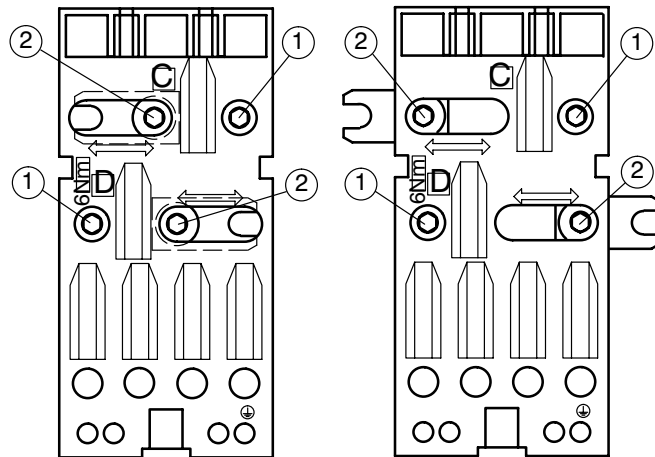

CAUTION

Destruction of power units!

Please note the tightening torque of 5 Nm for the screwed DC link connections.

Replacing components

6.2.3 DC link connection of VMW..F and DMW..F with water cooling

- ★ The DC link connection is made at the bottom side of the modules using the conductor bars supplied together with the unit:
 1. Push conductor bars into terminals “C” and “D” and tighten them firmly.
 2. Pull plastic cover from the accessory kit over the conductor bars and screw them to the metal brackets provided.

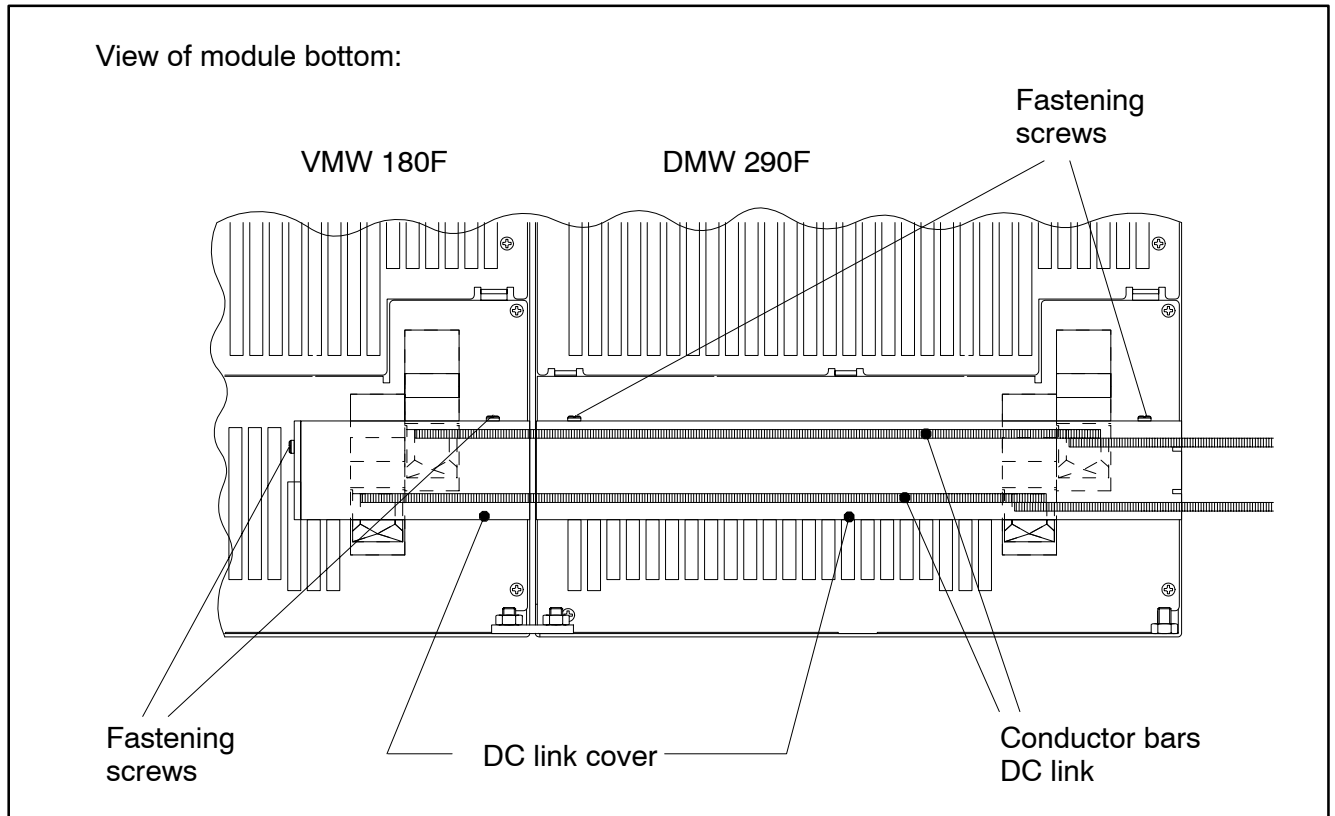

CAUTION

Tighten DC link screws with 18 Nm to protect the power supply unit.

Replacing components

Notes:

Annex

A Annex

A.1 Index

C

Computer errors, 4–28

Connection overview

DMA with analog interface, 5–3

DMA with CAN bus, 5–5

DMA with positioning function (MC), 5–3

DMA with PROFIBUS–DP, 5–6

DMA with SERCOS interface, 5–4

Frequency inverter with analog interface, 5–7

Stand-alone module DS, 5–8

VMA..B,C,D,F supply modules, 5–2

VMA..K supply modules, 5–1

VMA..KR supply modules, 5–2

D

DC link connection

compact mechanics without backplane module,
6–3

with backplane modules, 6–4

with water cooling, 6–5

Documentation, 1–9

E

Earth-leakage circuit-breaker, 2–3

Earthing, 2–1

EMC Directive, 1–1, 3–1

EMC product standard, 1–1

EMERGENCY–STOP devices, 1–6

Error displays

all without frequency inverter, 4–5

Computer errors, 4–28–4–32

Frequency inverter, 4–31

PROFIBUS errors, 4–28

VMA..KB, VMA..KE supply modules, 4–1

Error numbers P–0–0095, 4–14

ESD

Electrostatic discharge, 1–8

grounding, 1–8

workplace, 1–8

ESD-sensitive components, 1–8

EU design type certification, 3–2

F

Floppy disk drive, 1–9

G

Grounding bracelet, 1–8

H

Hard disk drive, 1–9

Holding brake, 6–1

I

IT protective system, 2–1

L

Low-Voltage Directive, 1–1, 3–1

M

Machinery Directive, 3–1

Machinery directive, 1–2

Mains connection, 2–1

Modules sensitive to electrostatic discharge. *See*
ESD-sensitive components

P

PROFIBUS errors, 4–28

Q

Qualified personnel, 1–3

R

Release, 1–10

Replacing components

Drive modules, 6–3

Motors, 6–1

RSU, 3–2

RSU, redundant safety monitoring, 3–2

S

Safety instructions, 1–5

Safety markings, 1–4

Spare parts, 1–7

Standard operation, 1–1

Status displays

Frequency inverter, 4–29

Stand-alone module DS, 4–4

Three-phase modules DM, 4–4

VMA..KB, VMA..KE supply modules, 4–1

VMA..KR, VMA..B,C,D,F supply modules, 4–2

Supply modules VMA..K, Connection overview, 5–1

T

Test activities, 1–7

Annex

Tightening torque

DC link in backplane modules, 6–4

DC link in compact mechanics, 6–3

Power connection, 6–3

Trademarks, 1–10

U

UL/CSA certification, 3–3

installation and operation, 3–3

W

Warnings

Frequency inverter, 4–29

VMA..KB, VMA..KE supply modules, 4–1

VMA..KR, VMA..B,C,D,F, 4–3

Bosch Rexroth AG
Electric Drives and Controls
Bgm.-Dr.-Nebel-Str. 2
97816 Lohr a. Main, Germany
info@boschrexroth.de
www.boschrexroth.de